



LEOS

TCCRX
PROFESSIONAL LINE



01

ACCESSORI - ACCESSORIES 2024

FREE WEIGHTS

MANUBRI IN URETANO
URETHANE DUMBBELLS

I - Le teste monoblocco unite da impugnatura godronata a terminali conici sono collegate a pressione e saldate a cordone continuo.
Dimensione impugnatura: 150xø30/32 mm. Dimensione testa: 25/106xø126x195 mm

*EN - The monobloc heads joined by a knurled handle to conical terminals are connected by pressure and welded with a continuous seam.
Handle size: 150xø32/34mm. Head size: 25/106xø126x195 mm*

cod. MPU-SET24

I - Set coppie manubri in uretano da 4 a 24 kg (salto da 2 kg).
EN - 10 pairs of urethane dumbbells 4-24 Kg (2kg step).

cod. MPU-2 - Kg. 2
cod. MPU-4 - Kg. 4
cod. MPU-6 - Kg. 6
cod. MPU-8 - Kg. 8
cod. MPU-10 - Kg. 10
cod. MPU-12 - Kg. 12
cod. MPU-14 - Kg. 14

cod. MPU-16 - Kg. 16
cod. MPU-18 - Kg. 18
cod. MPU-20 - Kg. 20
cod. MPU-22 - Kg. 22
cod. MPU-24 - Kg. 24
cod. MPU-26 - Kg. 26
cod. MPU-28 - Kg. 28

cod. MPU-30 - Kg. 30
cod. MPU-32 - Kg. 32
cod. MPU-34 - Kg. 34
cod. MPU-36 - Kg. 36
cod. MPU-38 - Kg. 38
cod. MPU-40 - Kg. 40



MANUBRI GOMMATI CON IMPUGNATURA ROTANTE ABSOLUTE
RUBBER ENCASED DUMBBELLS WITH ROTATING HANDLE ABSOLUTE

I - Le teste innestate a pressione su impugnatura a terminali conici vengono saldate a cordone continuo per conferire massima solidità al manubrio; l'impugnatura rotante in TPU godronato è montata su un albero in acciaio cromato per diminuire al massimo gli attriti di rotazione.
Dimensione impugnatura: 150xø32/34mm. Dimensione testa: 19,5/133xø126x193 mm

EN - The heads, pressure-fitted onto the handle with conical terminals, are welded with a continuous seam to give maximum solidity to the dumbbell. The knurled TPU rotating handle is mounted on a chrome-plated steel shaft to reduce friction. Handle size: 150xø32/34mm. Head size: 19,5/133xø126x193 mm

cod. MGPR-SET24

I - Set coppie manubri gommati con impugnatura rotante da 4 a 24 kg (salto da 2 kg).
EN - 10 pairs of rubber dumbbells with rotating handle 4-24 Kg (2kg step).

cod. MGPR-2 - Kg. 2	cod. MGPR-16 - Kg. 16	cod. MGPR-30 - Kg. 30	cod. MGPR-44 - Kg. 44
cod. MGPR-4 - Kg. 4	cod. MGPR-18 - Kg. 18	cod. MGPR-32 - Kg. 32	cod. MGPR-46 - Kg. 46
cod. MGPR-6 - Kg. 6	cod. MGPR-20 - Kg. 20	cod. MGPR-34 - Kg. 34	cod. MGPR-48 - Kg. 48
cod. MGPR-8 - Kg. 8	cod. MGPR-22 - Kg. 22	cod. MGPR-36 - Kg. 36	cod. MGPR-50 - Kg. 50
cod. MGPR-10 - Kg. 10	cod. MGPR-24 - Kg. 24	cod. MGPR-38 - Kg. 38	
cod. MGPR-12 - Kg. 12	cod. MGPR-26 - Kg. 26	cod. MGPR-40 - Kg. 40	
cod. MGPR-14 - Kg. 14	cod. MGPR-28 - Kg. 28	cod. MGPR-42 - Kg. 42	



MANUBRI GOMMATI**RUBBER ENCASED DUMBBELLS**

I - Le teste innestate a pressione sull'impugnatura in acciaio godronato a terminali conici, vengono saldate a cordone continuo per conferire massima solidità al manubrio. Dimensione impugnatura: 150xø25/34mm. Dimensione testa: 32/141xø127/195 mm

EN - The heads, pressure-fitted onto the knurled handle with conical terminals, are welded with a continuous seam to give maximum solidity to the handlebar. Handle size: 150xø25/34mm. Head size: 32/141xø127/195 mm

cod. MGP-SET24PRO

I - Set coppie manubri gommati da 4 a 24 kg (salto da 2 kg).

EN - 10 pairs of rubber dumbbells 4-24 Kg (2kg step).

cod. MGP-2PRO - Kg. 2

cod. MGP-4PRO - Kg. 4

cod. MGP-6PRO - Kg. 6

cod. MGP-8PRO - Kg. 8

cod. MGP-10PRO - Kg. 10

cod. MGP-12PRO - Kg. 12

cod. MGP-14PRO - Kg. 14

cod. MGP-16PRO - Kg. 16

cod. MGP-18PRO - Kg. 18

cod. MGP-20PRO - Kg. 20

cod. MGP-22PRO - Kg. 22

cod. MGP-24PRO - Kg. 24

cod. MGP-26PRO - Kg. 26

cod. MGP-28PRO - Kg. 28

cod. MGP-30PRO - Kg. 30

cod. MGP-32PRO - Kg. 32

cod. MGP-34PRO - Kg. 34

cod. MGP-36PRO - Kg. 36

cod. MGP-38PRO - Kg. 38

cod. MGP-40PRO - Kg. 40

cod. MGP-42PRO - Kg. 42

cod. MGP-44PRO - Kg. 44

cod. MGP-46PRO - Kg. 46

cod. MGP-48PRO - Kg. 48

cod. MGP-50PRO - Kg. 50

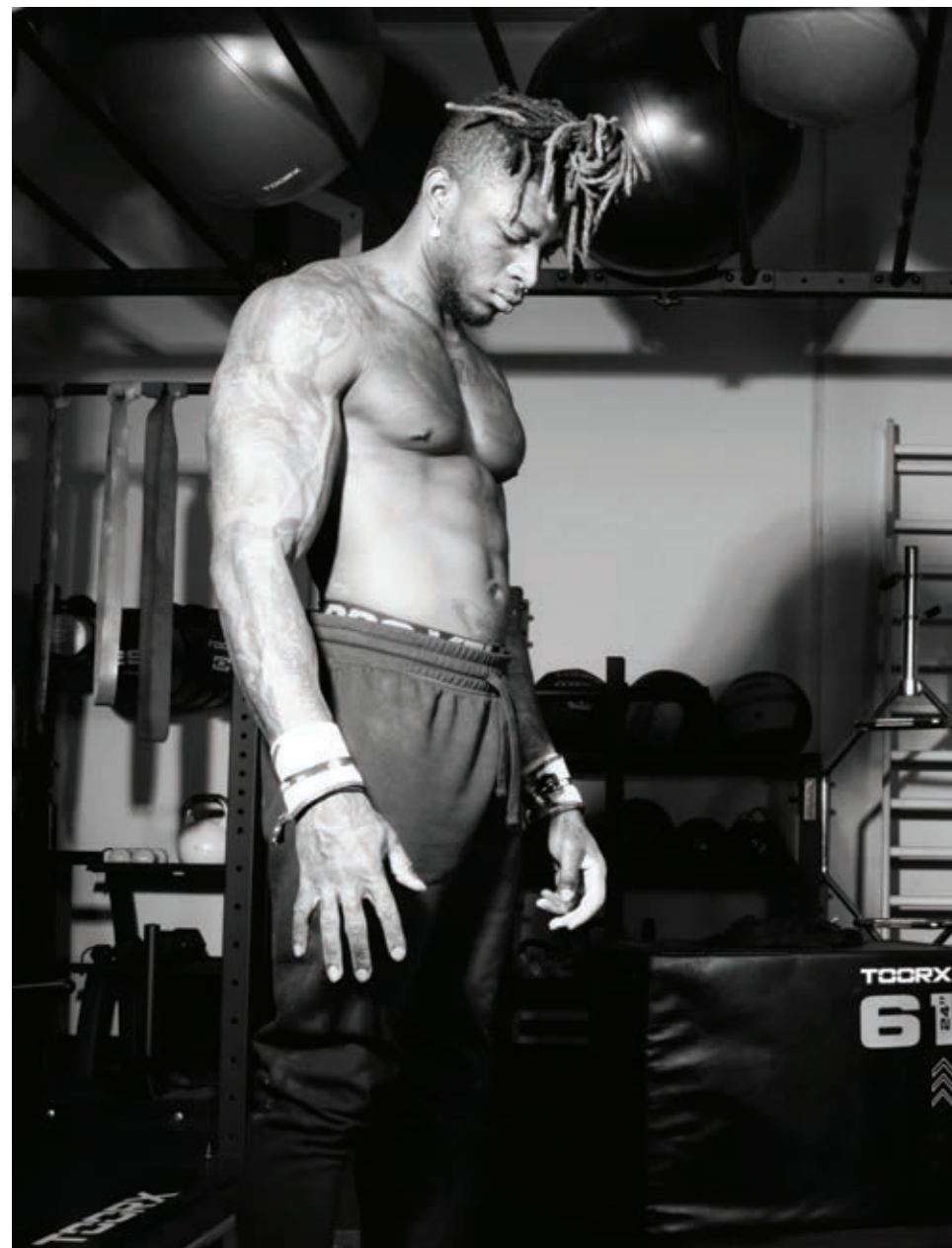

MANUBRI SELECTECH 552i
SELECTECH DUMBBELLS 552i



cod. BOW-552i

I - Manubrio a carico variabile con set di 15 pesi a selezione rapida. La ghiera selettiva con indici da 2 a 24 permette di selezionare il carico di lavoro da effettivi 2,3 a 23,8 kg. con salto di 2 kg. Dischi in acciaio gommato ed impugnatura ergonomica per una presa salda anche nei carichi più alti. L'alloggiamento in ABS, necessario durante le operazioni di selezione del carico, può essere ospitato nel rack trasportabile dedicato.

Peso regolabile da 2,3 a 23,8 kg

Selezionatore dei pesi: 2,3 - 3,4 - 4,5 - 5,6 - 6,7 - 7,8 - 8,9 - 10 - 11,1 - 13,4 - 15,7 - 18 - 20,3 - 22,7 - 23,8 kg

Dimensione manubrio 43 x 21 x 23 cm

EN - Adjustable selective dumbbell with 15 weight plates set. The selector dial indicates a possible range from 2 to 24, allowing you to select the working load from 2.3 to 23.8 kg. in increments of 2kg. Rubberized steel discs and ergonomic handles give a firm grip even with the heaviest loads The ABS housing, necessary during load selection operations, can be housed in the dedicated transportable rack.

Adjustable weight from 2,3 to 23,8 kg

Selectable weight plates : 2,3 - 3,4 - 4,5 - 5,6 - 6,7 - 7,8 - 8,9 - 10 - 11,1 - 13,4 - 15,7 - 18 - 20,3 - 22,7 - 23,8 kg

Dumbbell size 43 x 21 x 23 cm



MANUBRI SELECTECH 1090i
SELECTECH DUMBBELLS 1090i



cod. BOW-1090i

I - Manubrio a carico variabile con set di 17 pesi a selezione rapida. La ghiera selettiva con indici da 4 a 41 permette di selezionare il carico di lavoro da effettivi 4,5 a 40,8 kg. con salto di 2 kg. Dischi in acciaio gommato ed impugnatura ergonomica per una presa salda anche nei carichi più alti. L'alloggiamento in ABS, necessario durante le operazioni di selezione del carico, può essere ospitato nel rack trasportabile dedicato

Peso regolabile da 4,5 a 40,8 kg

Selezionatore dei pesi: 4,5 - 6,7 - 9,4 - 11,3 - 13,6 - 15,9 - 18,1 - 20,4 - 22,7 - 24,9 - 27,2 - 29,5 - 31,8 - 34 - 36,3 - 38,6 - 40,8 kg

Dimensione manubrio 44,5 x 24 x 25,5 cm

EN - Adjustable selective dumbbell with 17 weight plates set. The selector dial indicates a possible range from 4 to 41, allowing you to select the working load from 4.5 to 40.8 kg. in increments of 2kg. Rubberized steel discs and ergonomic handles give a firm grip even with the heaviest loads The ABS housing, necessary during load selection operations, can be housed in the dedicated transportable rack

Adjustable weight from 4,5 to 40,8 kg

Selectable weight plates : 4,5 - 6,7 - 9,4 - 11,3 - 13,6 - 15,9 - 18,1 - 20,4 - 22,7 - 24,9 - 27,2 - 29,5 - 31,8 - 34 - 36,3 - 38,6 - 40,8 kg

Dumbbell size 44,5 x 24 x 25,5 cm



RACK MANUBRI SELECTECH
SELECTECH DUMBBELLS RACK



cod. BOW-STAND

I - Carrello porta-manubri a carico regolabile (BOW-552i/BOW-1090i) dotato di supporto tablet con superficie gommata antiscivolo per un miglior grip. Ingombro ridotto e facile da montare. Manubrio a carico variabile risultato di una tecnologia all'avanguardia, è un'ottima soluzione salvaspazio che consente di avere a disposizione un'intera serie di manubri già pre-caricati in uno spazio molto ridotto. È sufficiente una semplice rotazione della ghiera graduata per selezionare il carico desiderato. La struttura meccanica interna ne garantisce la precisione di selezione del peso.

EN - Stand for adjustable selective dumbbells (BOW-552i/BOW-1090i) equipped with tablet holder with non-slip rubber surface for an ideal grip. Reduced footprint and easy to assemble. Adjustable selective dumbbell with 15 weight plates set. Based on a state-of-the-art technology, it is a great space-saving solution, which allows to have a whole set of dumbbells already pre-loaded in a very small space. All you have to do is a simple rotation of the graduated knob to select the desired weight. The internal mechanical structure guarantees the accuracy of weight selection.



MANUBRI ESAGONALI ABSOLUTE**HEX DUMBBELLS ABSOLUTE**

I - Le teste innestate a pressione sull'impugnatura a terminali conici, vengono saldate a cordone continuo per conferire massima solidità al manubrio. L'impugnatura è in acciaio godronato per favorire una presa salda e confortevole ed è finita con trattamento di brunitura protettiva. Teste rivestite in gomma di alta qualità.

Dimensione impugnatura: 135xø23/24mm. Dimensione testa: 47/147,5xH58/200 mm

EN - The pressure-engaged heads on the handle with conical terminals, are welded with continuous seam to give maximum solidity to the dumbbell. The handle is made with polished steel to ensure a firm and comfortable grip and is finished with protective burnishing treatment. High quality rubber coated heads.

Handle size: 135xø23/34mm. Head size: 47/147,5xH58/200 mm

cod. AMEG-1 - Kg. 1

cod. AMEG-2 - Kg. 2

cod. AMEG-3 - Kg. 3

cod. AMEG-4 - Kg. 4

cod. AMEG-5 - Kg. 5

cod. AMEG-6 - Kg. 6

cod. AMEG-7 - Kg. 7

cod. AMEG-7,5 - Kg. 7,5

cod. AMEG-8 - Kg. 8

cod. AMEG-9 - Kg. 9

cod. AMEG-10 - Kg. 10

cod. AMEG-12,5 - Kg. 12,5

cod. AMEG-15 - Kg. 15

cod. AMEG-17,5 - Kg. 17,5

cod. AMEG-20 - Kg. 20

cod. AMEG-22,5 - Kg. 22,5

cod. AMEG-25 - Kg. 25

cod. AMEG-27,5 - Kg. 27,5

cod. AMEG-30 - Kg. 30

cod. AMEG-32,5 - Kg. 32,5

cod. AMEG-35 - Kg. 35

cod. AMEG-37,5 - Kg. 37,5

cod. AMEG-40 - Kg. 40

cod. AMEG-42,5 - Kg. 42,5

cod. AMEG-45 - Kg. 45

cod. AMEG-47,5 - Kg. 47,5

cod. AMEG-50 - Kg. 50

**MANUBRI ESAGONALI GOMMATI****HEX RUBBER DUMBBELL**

I - Le teste innestate a pressione sull'impugnatura in acciaio godronato a terminali conici, vengono saldate a cordone continuo per conferire massima solidità al manubrio. Teste rivestite in gomma di alta qualità.

Dimensione impugnatura: 135xø23/24mm. Dimensione testa: 47/147,5xH58/200 mm

EN - The pressure-engaged heads on the knurled handle with conical terminals, are welded with continuous seam to give maximum solidity to the dumbbell. High quality rubber coated heads. Handle size: 135xø23/24mm. Head size: 47/147,5xH58/200 mm

cod. MEG-SET25

I - Set coppie manubri esagonali gommati da 2,5 a 25 kg (salto 2,5 kg).

EN - 10 pairs of hex rubber dumbbells 2,5-25 Kg (2,5kg step).

cod. MEG-1 - Kg. 1

cod. MEG-2 - Kg. 2

cod. MEG-3 - Kg. 3

cod. MEG-4 - Kg. 4

cod. MEG-5 - Kg. 5

cod. MEG-6 - Kg. 6

cod. MEG-7 - Kg. 7

cod. MEG-7,5 - Kg. 7,5

cod. MEG-8 - Kg. 8

cod. MEG-9 - Kg. 9

cod. MEG-10 - Kg. 10

cod. MEG-12,5 - Kg. 12,5

cod. MEG-15 - Kg. 15

cod. MEG-17,5 - Kg. 17,5

cod. MEG-20 - Kg. 20

cod. MEG-22,5 - Kg. 22,5

cod. MEG-25 - Kg. 25

cod. MEG-27,5 - Kg. 27,5

cod. MEG-30 - Kg. 30

cod. MEG-32,5 - Kg. 32,5

cod. MEG-35 - Kg. 35

cod. MEG-37,5 - Kg. 37,5

cod. MEG-40 - Kg. 40

cod. MEG-42,5 - Kg. 42,5

cod. MEG-45 - Kg. 45

cod. MEG-47,5 - Kg. 47,5

cod. MEG-50 - Kg. 50



MANUBRI CROMATI CHROMED DUMBBELLS

I - Teste inserite a pressione su terminali tronco-conici finite con cromatura a specchio. L'impugnatura anatomica è godronata per favorire la presa ed è finita con cromatura per proteggerne la superficie dall'ossidazione.

Dimensione impugnatura: 120xø25/28mm. Dimensione testa: 23/70xø42/90 mm

EN - Pressure-inserted heads on conical terminals with chrome plating finishing. The anatomical handle is knurled to facilitate grip and is finished with chrome plating to protect the surface from oxidation. Handle size: 120xø25/28mm. Head size: 23/70xø42/90 mm

cod. MC-SET

I - Set coppie manubri cromati con impugnatura anatomica da 1 a 10 Kg.

EN - 10 pairs of chromed dumbbells with ergonomic handle set (1 - 10 Kg).

cod. MC-1 - Kg. 1
cod. MC-2 - Kg. 2
cod. MC-3 - Kg. 3
cod. MC-4 - Kg. 4

cod. MC-5 - Kg. 5
cod. MC-6 - Kg. 6
cod. MC-7 - Kg. 7
cod. MC-8 - Kg. 8

cod. MC-9 - Kg. 9
cod. MC-10 - Kg. 10



MANUBRI VINILE VINYL DUMBBELLS

I - La struttura "pesante" è formata per fusione con struttura monoblocco a teste triangolari. Rivestiti in vinile con processo di dipping ad immersione.

EN - The "heavy" structure is formed by fusion with a monobloc structure with triangular heads. Vinyl coated with immersion dipping process.

cod. MVT-SET

I - Set coppie manubri in vinile con testa triangolare da 1 a 10 Kg.

EN - 10 pairs of vinyl dumbbells with triangular head set (1 - 10 Kg)

cod. MVT-1 - Kg. 1 cod. MVT-6 - Kg. 6
cod. MVT-2 - Kg. 2 cod. MVT-7 - Kg. 7
cod. MVT-3 - Kg. 3 cod. MVT-8 - Kg. 8
cod. MVT-4 - Kg. 4 cod. MVT-9 - Kg. 9
cod. MVT-5 - Kg. 5 cod. MVT-10 - Kg. 10



cod. MV-05 - Kg. 0.5 cod. MV-4 - Kg. 4
cod. MV-1 - Kg. 1 cod. MV-5 - Kg. 5
cod. MV-2 - Kg. 2 cod. MV-6 - Kg. 6
cod. MV-3 - Kg. 3



BILANCIERI DRITTI PRECARICATI**PRELOADED BARBELLS**

I - Le teste innestate a pressione sull'impugnatura a terminali conici, vengono saldate a cordone continuo per conferire massima solidità al bilanciere. L'asta dritta è in acciaio godronato per favorire una presa salda e confortevole; la finitura testurizzata antigraffio delle teste ne conserva l'estetica nel tempo. Lunghezza bilanciere: 1034/1320 mm.

Dimensione asta: 970/1060xø25/30 mm. Dimensione testa: ø127/195 mm

EN - The heads, pressure-fitted onto the handle with conical terminals, are welded in a continuous seam to give maximum solidity to the barbell. The straight shaft is made of knurled steel to ensure a firm and comfortable grip; the scratch-resistant textured finish preserves its aesthetics over time. Barbell length: 1034/1320 mm.

Shaft size: 970/1060xø25/30 mm. Head size: ø127/195 mm

cod. BDP-5 - Kg. 5

cod. BDP-10 - Kg. 10

cod. BDP-15 - Kg. 15

cod. BDP-20 - Kg. 20

cod. BDP-25 - Kg. 25

cod. BDP-30 - Kg. 30

cod. BDP-35 - Kg. 35

cod. BDP-40 - Kg. 40

cod. BDP-45 - Kg. 45

cod. BDP-50 - Kg. 50

**BILANCIERI CURL PRECARICATI****PRELOADED EZ CURL BARBELLS**

I - Le teste innestate a pressione sull'impugnatura a terminali conici, vengono saldate a cordone continuo per conferire massima solidità al manubrio. L'asta sagomata è in acciaio godronato per favorire una presa salda e confortevole; la finitura testurizzata antigraffio delle teste ne conserva l'estetica nel tempo. Lunghezza bilanciere: 1034/1320 mm.

Dimensione asta: 970/1060xø25/30 mm. Dimensione testa: ø127/195 mm

EN - The heads, pressure-fitted onto the handle with conical terminals, are welded in a continuous seam to give maximum solidity to the barbell. The curled shaft is made of knurled steel to ensure a firm and comfortable grip; the scratch-resistant textured finish preserves its aesthetics over time. Barbell length: 1034/1320 mm.

Shaft size: 970/1060xø25/30 mm. Head size: ø127/195 mm

cod. BSP-5 - Kg. 5

cod. BSP-10 - Kg. 10

cod. BSP-15 - Kg. 15

cod. BSP-20 - Kg. 20

cod. BSP-25 - Kg. 25

cod. BSP-30 - Kg. 30

cod. BSP-35 - Kg. 35

cod. BSP-40 - Kg. 40

cod. BSP-45 - Kg. 45

cod. BSP-50 - Kg. 50



BILANCIERE SELECTECH 2080
BARBELL SELECTECH 2080



cod. BOW-2080

I - Bilanciere a carico variabile da 9 a 36 kg. Con bilanciere dritto e curl, sostituisce un set da 14 bilancieri.

I 7 carichi selezionabili sono 9.1, 13.6, 18.1, 22.7, 27.2, 31.8, 36.3 kg. Dimensioni 150 x 30 x H32.

EN - Adjustable selective barbell from 9 to 36 kgs. With straight and curl barbells, replaces a set of 14 barbells. 7 loads available: 9.1, 13.6, 18.1, 22.7, 27.2, 31.8, 36.3 kg. Dimensions 150 x 30 x H32.



KIT EXTRA 18 KG PER
BILANCIERE 2080



18 KG UPGRADE KIT FOR BARBELL 2080

cod. BOW-2080-18

I - Aumenta il carico massimo a 54 kg aggiungendo i 4 carichi: 40.5, 45, 49.5, 54 kg.

EN - Increase the max weight to 54 kg with 4 steps: 40.5, 45, 49.5, 54 kg.



STAND PER BILANCIERE 2080
STAND FOR BARBELL 2080



cod. BOW-2080-STAND

I - Stand per bilanciere 2080 a carico variabile con porta tablet/smartphone.

EN - Stand for adjustable selective barbell 2080 with tablet/smartphone holder.



RASTRELLIERA PORTA MANUBRI TONDI COMPONIBILE A 3 RIPIANI **MODULAR RACK FOR ROUND DUMBBELLS WITH 3 SHELVES**

cod. RPMC-3

I - Struttura portante modulare a 3 ripiani pensata per stivare manubri a testa tonda. Sostituendo le sedi in plastica incluse con il vassoio VME, diventa adatta allo stivaggio di manubri esagonali. Capacità minima di stivaggio: 12 coppie manubri testa tonda
Dimensione prodotto: 180x100x120cm.

EN - Modular structure with 3 shelves designed to store round head dumbbells. Replacing the plastic seats with the shelf VME, it is suitable for hex dumbbells storage. Minimum storage capacity: 12 pairs of round head dumbbells
Product size: 180x100xH120cm.



Manubri non inclusi.
Dumbbells not included

RASTRELLIERA PORTA MANUBRI TONDI COMPONIBILE A 2 RIPIANI **MODULAR RACK FOR ROUND DUMBBELLS WITH 2 SHELVES**

cod. RPMC-2

I - Struttura portante modulare a 2 ripiani pensata per stivare manubri a testa tonda. Sostituendo le sedi in plastica incluse con il vassoio VME, diventa adatta allo stivaggio di manubri esagonali. Capacità minima di stivaggio: 8 coppie manubri testa tonda
Dimensione prodotto: 180x92xH84,5 cm.

EN - Modular structure with 2 shelves designed to store round head dumbbells. Replacing the plastic seats with the shelf VME, it is suitable for hex dumbbells storage. Minimum storage capacity: 8 pairs of round head dumbbells.
Product size: 180x92xH84,5 cm.



Manubri non inclusi.
Dumbbells not included

TELAIO DI SUPPORTO PER 3 RIPIANI SIDE FOR 3 SHELVES

cod. TS-3

I - Telaio monolitico di supporto dei ripiani, elemento strutturale verticale progettato per ospitare 3 ripiani: assemblando telaio + vassoi in serie ad una rastrelliera RPMC-3 è possibile ottenere uno storage a più campate, che può ospitare sia manubri esagonali che a testa tonda. Dimensione prodotto: 100x10x120cm.

EN - Monolithic shelf support frame, vertical structural element designed to assembly 3 shelves: by assembling it + shelves in series with an RPMC-3 rack it is possible to obtain multi-span rack, which can store both hexagonal and round head dumbbells. Product size: 100x10xH120cm.



TELAIO DI SUPPORTO PER 2 RIPIANI SIDE FOR 2 SHELVES

cod. TS-2

I - Telaio monolitico di supporto dei ripiani, elemento strutturale verticale progettato per ospitare 2 ripiani: assemblando telaio + vassoi in serie ad una rastrelliera RPMC-2 è possibile ottenere uno storage a più campate, che può ospitare sia manubri esagonali che a testa tonda. Dimensione prodotto: 100x10x90cm.

EN - Monolithic shelf support frame, vertical structural element designed to assembly 2 shelves: by assembling it + shelves in series with an RPMC-2 rack it is possible to obtain multi-span rack, which can store both hexagonal and round head dumbbells. Product size: 100x10xH90cm.



RIPIANO STANDARD STANDARD SHELF

cod. RSTD

I - Ripiano portante, costituisce l'elemento strutturale orizzontale a collegamento dei telai di supporto: se montato con le nervature verso l'alto può ospitare 4 coppie di sedi per manubri a testa tonda (SSMT) montandolo con le nervature verso il basso invece, può ospitare il vassoio per lo stivaggio dei manubri esagonali (VME). Dimensione prodotto: 161x32,5x6 cm.

EN - Load-bearing shelf, it constitutes the horizontal structural element connecting the sides: if mounted with the ribs facing upwards, it can accommodate 4 pairs of seats for round-headed dumbbells (SSMT); by mounting it with the ribs facing downwards, it can accommodate the shelf for storing the hexagonal dumbbells (VME). Product size: 161x32,5x6 cm.



Esempio di RSTD assemblato
Example of RSTD assembled

VASSOIO MANUBRI ESAGONALI HEX DUMBBELLS SHELF

cod. VME

I - Ripiano privo di divisioni, da montare sul ripiano standard (RSTD) capovolto: questa configurazione consente lo stivaggio dei manubri esagonali in quantità dipendente dalle pezzature riposte. Dimensione prodotto: 160x40x7cm.

EN - Shelf without divisions, to be mounted on the standard shelf (RSTD) upside down: this configuration allows the storage of hexagonal dumbbells in quantities depending on the size of the items stored. Product size: 160x40xH7cm.



Esempio di VME assemblato
Example of VME assembled

SET 16 SEDI PER MANUBRI TONDI SET OF 16 ROUND DUMBBELLS SEATS

cod. SSMT

I - Sedi in ABS per lo stoccaggio dei manubri a testa tonda - 16 pezzi.

EN - ABS seats for storing round-headed dumbbells - 16 pieces.



Esempio di SSMT assemblato
Example of SSMT assembled



**RASTRELLIERA STUDIO
PORTA MANUBRI A 2 RIPIANI**
STUDIO RACK FOR DUMBBELLS WITH 2 SHELVES

cod. RPM-B12

I - Rastrelliera porta manubri a 2 ripiani 10/12 coppie.
Dimensione prodotto: 192x87xH95 cm.

*EN - Dumbbells rack with 2 shelves (10/12 pairs).
Product size: 192x87xH95 cm.*



**RASTRELLIERA
PORTA MANUBRI 10 COPPIE**
DUMBBELLS RACK 10 PAIRS

cod. RPM-B10

I - Rastrelliera porta manubri a colonna 10 coppie.
Sedi di appoggio dei manubri con protezioni in PE.
Dimensione prodotto: 47x47xH121 cm

*EN - Dumbbells rack 10 pairs. Seats with PE protections.
Product size: 47x47xH121 cm*



**RASTRELLIERA
PORTA MANUBRI IN VINILE**
VINYL DUMBBELLS RACK

cod. RMV-B

I - Rastrelliera porta manubri in vinile con ruote di trasporto.
Dimensione prodotto: 100x50xH105 cm.

*EN - Vinyl dumbbells rack with moving wheels.
Product size: 100x50xH105 cm.*



**RASTRELLIERA
PORTA MANUBRI 6 COPPIE
DUMBBELLS RACK 6 PAIRS**

cod. RPM-B6

I - Rastrelliera porta manubri 6 coppie.
Dimensione prodotto: 72x52xH107 cm.

*EN - Dumbbells rack 6 pairs.
Product size: 72x52xH107 cm.*



**RASTRELLIERA
PORTA MANUBRI A 3 RIPIANI
DUMBBELLS RACK WITH 3 SHELVES**

cod. RPM-B3R

I - Rastrelliera porta manubri a 3 ripiani. Adatto a manubri fino a 22,5 Kg
Dimensione prodotto: 134x54,5xH95 cm

*EN - Dumbbells rack with 3 shelves. Suitable for dumbbells up to 22.5 kg.
Product size: 134x54,5xH95 cm*



**RASTRELLIERA
PORTA BILANCIERI 5 POSTI
BARBELLS RACK 5 PLACES**

cod. RPBP-5

I - Progettata per riporre 5 bilancieri precaricati. Sedi di appoggio del bilanciere protette con inserti in HDPE.
Dimensione prodotto: 82,3x78,3xH130,6 cm.

*EN - Suitable for preloaded barbells. Barbell seats protected with HDPE pads.
Product size: 82,3x78,3xH130,6 cm.*



DISCHI OLIMPICI IN GHISA GOMMATA

OLYMPIC RUBBER COATED CAST IRON WEIGHT PLATES

I - Disco olimpico ricoperto in gomma inodore con finitura gofrata e design "trigrip" e boccola svasata in acciaio inox per un agevole carico-scarico della barra. Boccola olimpica 50mm.

EN - Odorless rubber coated olympic weight plates, with rough finishing and 'trigrip' design stainless steel bushing for a more comfortable loading-unloading. Olympic bushing 50mm.

cod. DGG-TG1.25 - Kg. 1,25 tri grip
 cod. DGG-TG2.5 - Kg. 2,5 tri grip
 cod. DGG-TG5 - Kg. 5 tri grip
 cod. DGG-TG10 - Kg. 10 tri grip
 cod. DGG-TG15 - Kg. 15 tri grip
 cod. DGG-TG20 - Kg. 20 tri grip
 cod. DGG-TG25 - Kg. 25 tri grip

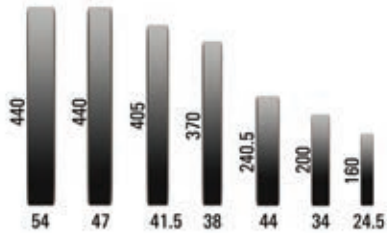

DISCHI OLIMPICI IN GHISA

OLYMPIC CAST IRON WEIGHT PLATES

I - Disco olimpico in ghisa nera con design "trigrip". Boccola olimpica 50mm.

EN - Olympic cast iron weight plates with 'trigrip' design Olympic bushing 50mm.

cod. DGN-TG1.25 - Kg. 1,25 tri grip
 cod. DGN-TG2.5 - Kg. 2,5 tri grip
 cod. DGN-TG5 - Kg. 5 tri grip
 cod. DGN-TG10 - Kg. 10 tri grip
 cod. DGN-TG15 - Kg. 15 tri grip
 cod. DGN-TG20 - Kg. 20 tri grip
 cod. DGN-TG25 - Kg. 25 tri grip

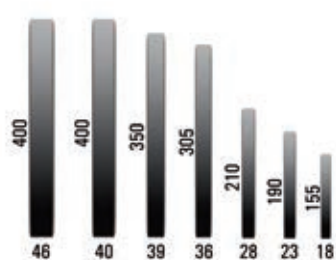

DISCHI BUMPER COMPETITION

COMPETITION BUMPER WEIGHT PLATES

I - Disco olimpico in gomma colorata con piastra centrale in acciaio.
La colorazione dei dischi è conforme ai regolamenti IWF.
Diametro disco 45cm. / Boccola olimpica 50mm.

*EN - Olympic coloured rubber weight plate with steel core.
Colours IWF compliant. Plate diameter 45cm. / Olympic bushing 50mm.*

cod. DBC-5 - Kg. 5
cod. DBC-10 - Kg. 10
cod. DBC-15 - Kg. 15
cod. DBC-20 - Kg. 20
cod. DBC-25 - Kg. 25

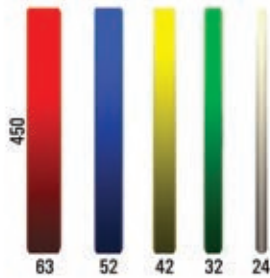

DISCHI BUMPER CHALLENGE

CHALLENGE BUMPER WEIGHT PLATES

I - Disco olimpico in gomma colorata con boccola svasata in acciaio inox.
La colorazione dei dischi è conforme ai regolamenti IWF.
Diametro disco 45cm. / Boccola olimpica 50mm.

*EN - Olympic coloured rubber weight plate with bushing in inox steel.
Colours IWF compliant. Plate diameter 45cm. / Olympic bushing 50mm.*

cod. DBCH-5 - Kg. 5
cod. DBCH-10 - Kg. 10
cod. DBCH-15 - Kg. 15
cod. DBCH-20 - Kg. 20
cod. DBCH-25 - Kg. 25

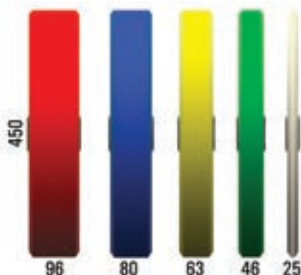

DISCHI BUMPER CRUMB**BUMPER CRUMB WEIGHT PLATES**

I - Disco olimpico in gomma puntinata con boccia svasata in acciaio inox. Silenziosità e una minore capacità di rimbalzo, rendono i dischi bumper crumb ideali per gli allenamenti funzionali. Non adatti a centri crosstraining. Diametro disco 45cm. / Boccia olimpica 50mm.

EN - Olympic weight plates made with rubber with coloured dots. No noise and low rebounding capacity make the crumb weight plates perfect for functional training. Not suitable for crosstraining boxes. Diametro disco 45cm. / Boccia olimpica 50mm.

cod. DBCR-5 - Kg. 5 cod. DBCR-20 - Kg. 20
 cod. DBCR-10 - Kg. 10 cod. DBCR-25 - Kg. 25
 cod. DBCR-15 - Kg. 15

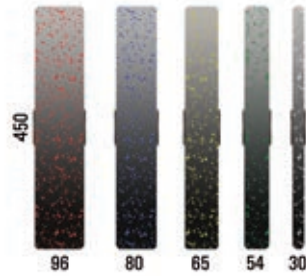
**DISCHI BUMPER TRAINING ABSOLUTE****TRAINING BUMPER WEIGHT PLATES ABSOLUTE**

I - Disco olimpico in gomma nera con boccia svasata in acciaio inox. Colore di numeri e grafica conformi ai regolamenti IWF. Diametro disco 45cm. / Boccia olimpica 50mm.

EN - Olympic black rubber weight plate with stainless steel bushing. Colours IWF compliant. Plate diameter 45cm. / Olympic bushing 50mm.

cod. ADBT-5 - Kg. 5
 cod. ADBT-10 - Kg. 10
 cod. ADBT-15 - Kg. 15
 cod. ADBT-20 - Kg. 20
 cod. ADBT-25 - Kg. 25

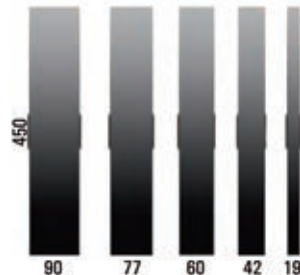

**COPPIA DISCHI TECHNIQUE
TECHNIQUE PLATES**

I - Dischi olimpici in HDP con foro 50 mm. Ideati per la didattica degli esercizi con bilanciere libero.

EN - Olympic HDP weight plates with 50 mm diameter hole. Designed for teaching.

cod. CDT-2.5 - Kg. 2.5
cod. CDT-5 - Kg. 5



**COPPIA DISCHI MICROCARICHI GOMMATI
FRACTIONAL RUBBER COATED WEIGHT PLATES**

I - Coppia dischi microcarichi olimpici in gomma nera con foro ø 50 mm. Disponibili in 5 varianti di peso, consentono un allenamento preciso con aumento graduale del carico.

EN - Fractional black rubber weight plates with ø50 mm hole. Available in 5 different weights, these plates allow a very precise workout with gradual loading increase.

cod. CDBM-0.5 - 2 x 0,5 kg
cod. CDBM-1 - 2 x 1 kg
cod. CDBM-1.5 - 2 x 1,5 kg
cod. CDBM-2 - 2 x 2 kg
cod. CDBM-2.5 - 2 x 2,5 kg



**COPPIA DISCHI MICROCARICHI IN ACCIAIO
FRACTIONAL STEEL COATED WEIGHT PLATES**

I - Coppia dischi microcarichi in acciaio di colore nero con foro ø50 mm. Disponibili in 6 varianti di peso, consentono un allenamento preciso con aumento graduale del carico.

EN - Fractional steel weight plates, with 50 mm diameter. These plates allow a very precise workout with gradual loading increase. Available in 6 different weights.

cod. CDM-0.25 - 2 x 0,25 kg
cod. CDM-0.5 - 2 x 0,5 kg
cod. CDM-1 - 2 x 1 kg
cod. CDM-1.5 - 2 x 1,5 kg
cod. CDM-2 - 2 x 2 kg
cod. CDM-2.5 - 2 x 2,5 kg



RASTRELLIERA PORTA DISCHI STUDIO **STUDIO RACK FOR WEIGHT PLATES**

cod. RPD-B50STUDIO

I - Rastrelliera ad 8 manicotti di carico. Interasse adatto a dischi "trigrip" design.
Dimensione prodotto: 116x116xH130 cm

*EN - Rack for weight plates with 8 plates holders suitable for "trigrip" design weight plates.
Product size: 116x116xH130 cm*



RASTRELLIERA PORTA DISCHI PRO **WEIGHT PLATES RACK PRO**

cod. RPD-B50PRO

I - Rastrelliera con 8 manicotti di carico. Interasse adatto a dischi "trigrip" design.
Dimensione prodotto: 58x53xH96 cm

*EN - Rack for weight plates with 8 plates holders suitable for "trigrip" design weight plates.
Product size: 58x53xH96 cm*



RASTRELLIERA VERTICALE PORTA DISCHI BUMPER E BILANCIERI **VERTICAL BUMPER WEIGHT PLATES AND BARBELLS RACK**

cod. RBV-B6

I - Rastrelliera verticale porta dischi con 6 manicotti di carico e 6 porta bilancieri. Interasse adatto a dischi bumper. Dimensione prodotto: 70x70xH140,5 cm.

EN - Vertical bumper weight plates and barbells rack with 6 plate holders and 6 barbell seats. Product size: 70x70xH140,5 cm.



RASTRELLIERA ORIZZONTALE PORTA DISCHI BUMPER **HORIZONTAL BUMPER WEIGHT PLATES RACK**

cod. RBO

I - Rastrelliera porta dischi bumper orizzontale con 8 divisioni, maniglia e ruote posteriori per lo spostamento. Dotata di manicotto per stivaggio microcarichi. Dimensione prodotto: 142x31xH27 cm

EN - Horizontal bumper weight plates rack with 8 dividers, handle and rear moving wheels. With fractional bumper weight plates holders. Product size: 142x31xH27 cm



BILANCIERE CROSS COMPETITION 1000**CROSS COMPETITION 1000 BARBELL****cod. BO-1000**

I - Bilanciere olimpico con finitura hard chrome. Manicotti torniti antiscivolo montati su 4 cuscinetti a rulli e 2 bronzine. Carico max statico 1000 Kg. Lunghezza 220 cm. Peso 20 Kg. Diametro impugnatura 28 mm.

EN - Olympic chromed barbell hard chromed finishing. Sleeves with non-slip turned surface - 4 needle bearings + 2 bronze bushings. Max load 1000 Kg. Length. 220 cm. Weight 20 Kg. Grip dia. 28 mm.

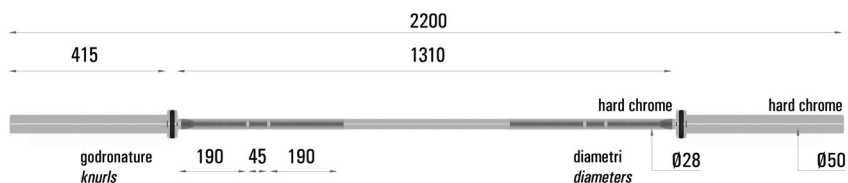
**BILANCIERE CROSS MASTER 700****CROSS MASTER 700 BARBELL****cod. BO-700**

I - Bilanciere olimpico con finitura hard chrome. Manicotti torniti antiscivolo montati su 3 cuscinetti a rulli e 2 bronzine. Carico max statico 700 Kg. Lunghezza 220 cm. Peso 20 Kg. Diametro impugnatura 28 mm.

EN - Olympic chromed barbell hard chromed finishing. Sleeves with non-slip turned surface - 3 needle bearings + 2 bronze bushings. Max load 700 Kg. Length. 220 cm. Weight 20 Kg. Grip dia. 28 mm.

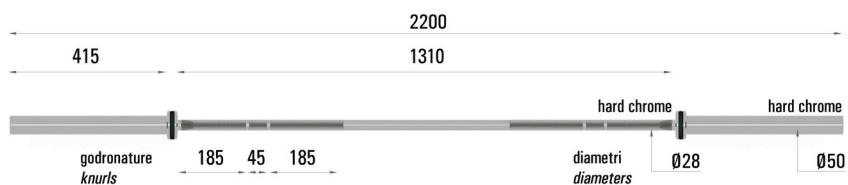

BILANCIERE CROSS CHALLENGE 450**CROSS CHALLENGE 450 BARBELL****cod. BO-450**

I - Bilanciere olimpico in acciaio brunito. Manicotti con finitura superficiale hard chrome torniti antiscivolo montati su 2 cuscinetti a rulli e 2 bronzine. Carico max statico 450 Kg. Lunghezza 220 cm. Peso 20 Kg. Diametro impugnatura 28 mm.

EN - Olympic black oxide barbell. Sleeves with non-slip turned surface - 2 needle bearings + 2 bronze bushings. Max load 450 Kg. Length. 220 cm. Weight 20 Kg. Grip dia. 28 mm.

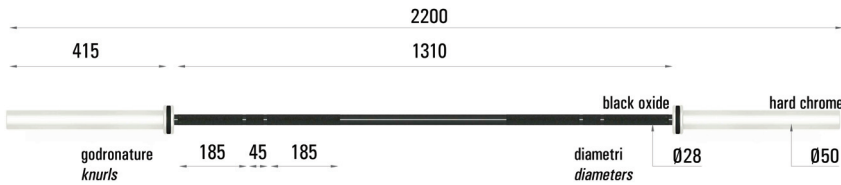
**BILANCIERE CROSS CHALLENGE WOMEN 250****CROSS CHALLENGE WOMEN 250 BARBELL****cod. BO-250**

I - Bilanciere olimpico in acciaio brunito. Manicotti con finitura superficiale hard chrome torniti antiscivolo montati su 2 cuscinetti a rulli e 2 bronzine. Carico max statico 250 Kg. Lunghezza 201 cm. Peso 15 Kg. Diametro impugnatura 25 mm.

EN - Olympic black oxide barbell. Sleeves with non-slip turned surface - 2 needle bearings + 2 bronze bushings. Max load 250 Kg. Length. 201 cm. Weight 15 Kg. Grip dia. 25 mm.

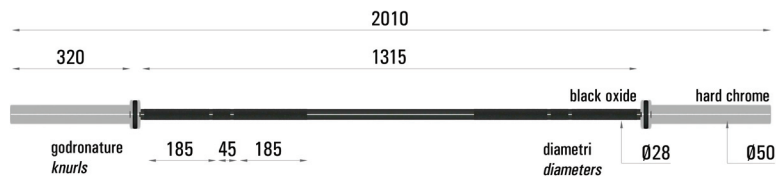

BILANCIERE CROSS TECHNIQUE 200**CROSS TECHNIQUE 200 BARBELL****cod. BO-TEC200**

I - Bilanciere olimpico in alluminio con manicotti montati su 2 bronzine. Pensato per la didattica. Carico max statico 20 Kg. NON DROPPABILE. Lunghezza 200 cm. Peso 5 Kg. Diametro impugnatura 25 mm.

EN - Aluminum olympic barbell with steel sleeves - 2 bronze bushings. Designed for teaching. Max load 20 Kg. NOT DROPPABLE. Length. 200 cm. Weight 5 Kg. Grip dia. 25 mm.

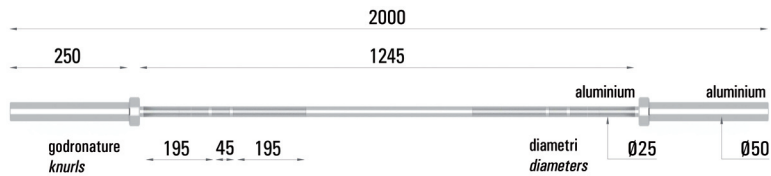
**BILANCIERE CROSS TECHNIQUE 180****CROSS TECHNIQUE 180 BARBELL****cod. BO-TEC180**

I - Bilanciere olimpico in alluminio con manicotti in acciaio cromato montati su 2 bronzine. Pensato per la didattica. Carico max statico 50 Kg. NON DROPPABILE. Lunghezza 180 cm. Peso 7,5 Kg. Diametro impugnatura 28 mm.

EN - Aluminum olympic barbell with steel sleeves - 2 bronze bushings. Designed for teaching. Max load 50 Kg. NOT DROPPABLE. Length. 180 cm. Weight 7,5 Kg. Grip dia. 28 mm.

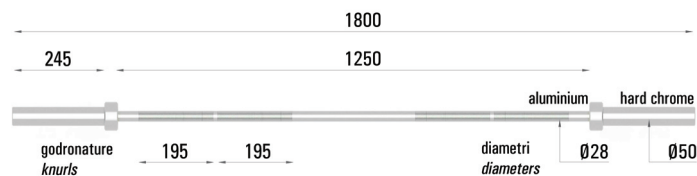

BILANCIERE OLIMPICO ESAGONALE TRIGRIP**TRIGRIP OLYMPIC HEX BARBELL****cod. OSB-PRO**

I - Bilanciere olimpico esagonale con tripla impugnatura. Telaio a sezione scatolare. Carico max statico 300 Kg. Lunghezza 180 cm. Lunghezza manicotti 40 cm. Peso 28 Kg. Diametro impugnature 25/38/50 mm.

EN - Olympic hex chromed shrug bar with triple grip - spring clip safety collars. Max static load 300 Kg. Length 180 cm. Sleeves length 40 cm. Weight 28 Kg. Grip dia 25/38/50 mm.

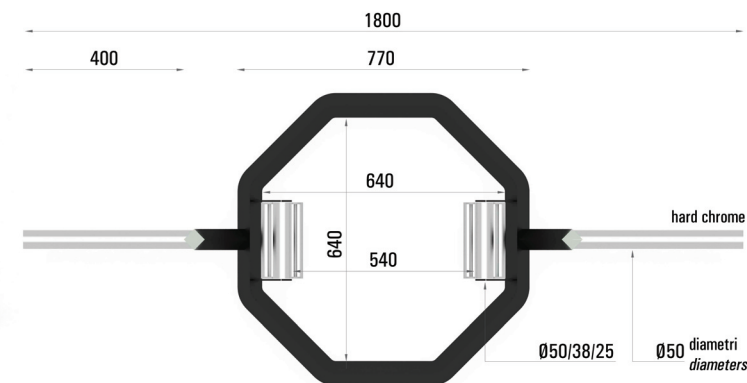
**SPECIAL****BILANCIERE OLIMPICO ESAGONALE****OLYMPIC HEX BARBELL****cod. OSB**

I - Bilanciere olimpico esagonale con doppia impugnatura. Carico max statico 300 Kg. Lunghezza 175 cm. Lunghezza manicotti 41 cm. Peso 28 Kg. Diametro impugnature 25 mm.

EN - Olympic hex chromed shrug bar with dual-handle - spring clip safety collars - grip 25 mm. - Max static load 300 Kg. Length 175 cm. Sleeves length 41 cm. Weight 28 Kg. Grip dia 25 mm.

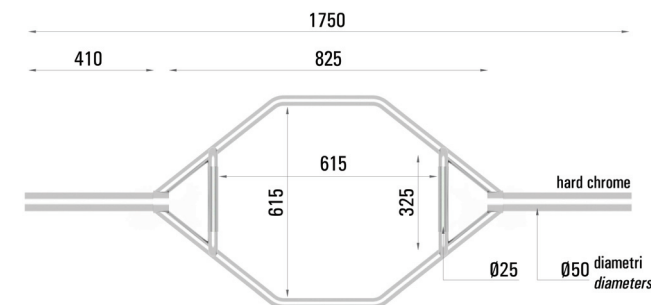
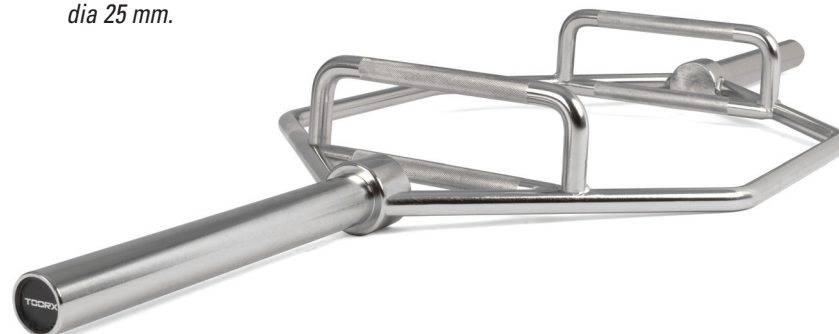
**SPECIAL**

SAFETY SQUAT BAR

cod. SSB

I - Bilanciere cromato sagomato con roller di appoggio singolo per il collo e doppio per le spalle. Manicotti hard chromed con tornitura antiscivolo montati su 2 cuscinetti a sfera e 2 bronzine. Carico max statico 320 kg. Lunghezza 220 cm. Lunghezza Manicotti 31,5 cm. Peso 20 Kg. Diametro impugnatura 28 mm. Roller spalle 250 x ø115mm. Roller collo 265 x ø80mm.

EN - Chromed barbell with neck and shoulders roller pads. Chromed barbell chromed sleeves + non-slip turned surface - 2 needle bearings + bronze bushings - max static load 320 Kg. Length 220 cm. Sleeves length 31,5 cm. Weight 20 Kg. Grip dia 28 mm. Rollers (shoulders) 250 x ø115mm. Roller (neck) 265 x ø80mm.

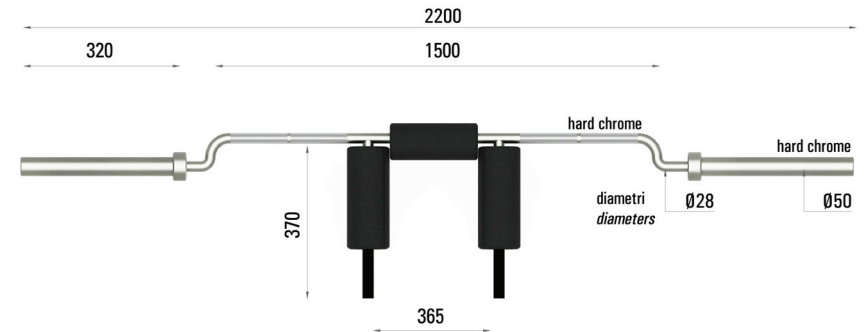

OFFSET BAR

cod. OB

I - Bilanciere cromato sagomato per utilizzo in panca supina o seal row bench. Manicotti hard chromed montati su 2 cuscinetti a sfera e 2 bronzine. carico max statico 320 kg. Lunghezza 220 cm. Lunghezza Manicotti 41 cm. Peso 20 Kg. Diametro impugnatura 28mm.

EN - Chromed barbell shaped for supine bench or seal row bench use. Hard chromed sleeves - 2 needle bearings + bronze bushings - max static load 320 Kg. Length 220 cm. Sleeves length 41 cm. Weight 20 Kg. Grip ø 28 mm.

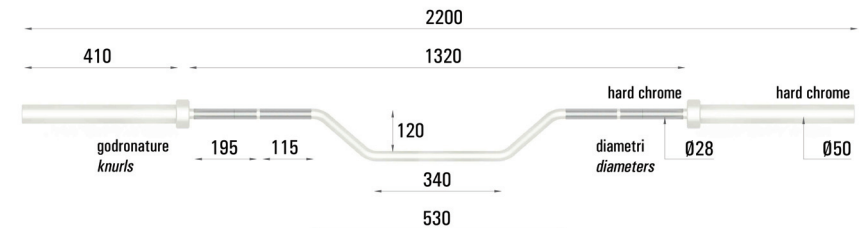

BILANCIERE POWER TRAINING 220**POWER TRAINING 220 BARBELL****cod. B0-220**

I - Bilanciere olimpico con finitura superficiale hard chromed. Carico max. statico 320 Kg.
NON DROPPABILE. Lunghezza 220 cm. Lunghezza manicotti 41,5 cm. Peso 20 Kg.
Diametro impugnatura 28 mm.

EN - Olympic hard chromed barbell – sleeves with bronze bushings - max static load 320 Kg.
NOT DROPPABLE. Length 220 cm. Sleeves length 41,5 cm. Weight 20 Kg. Grip dia 28 mm.

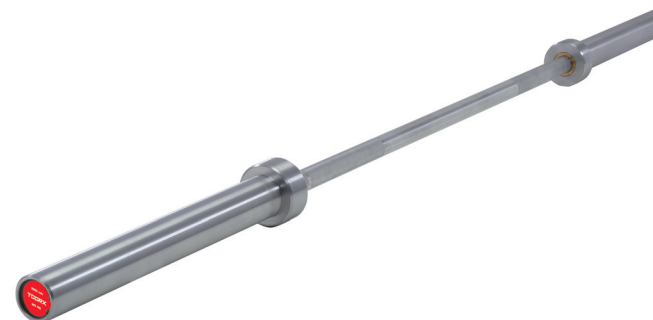
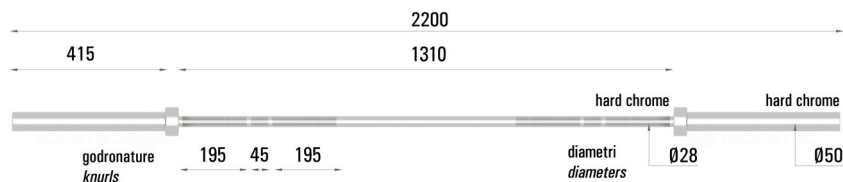
**BILANCIERE POWER TRAINING 180****POWER TRAINING 180 BARBELL****cod. B0-180**

I - Bilanciere olimpico con finitura superficiale hard chromed. Carico max. statico 320 Kg.
NON DROPPABILE. Lunghezza 180 cm. Lunghezza manicotti 25 cm. Peso 15 Kg.
Diametro impugnatura 28 mm.

EN - Olympic chromed barbell – sleeves with bronze bushings - max static load 320 Kg.
NOT DROPPABLE. Length 180 cm. Sleeves length 25 cm. Weight 15 Kg. Grip dia 28 mm.

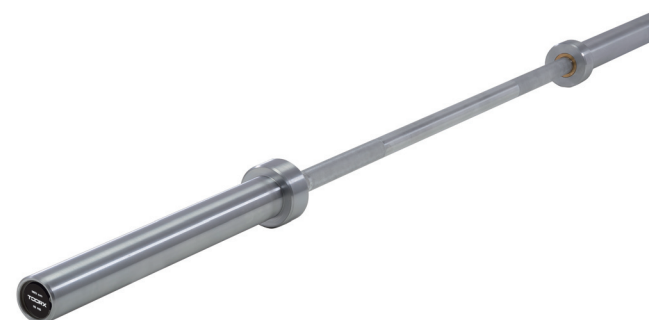
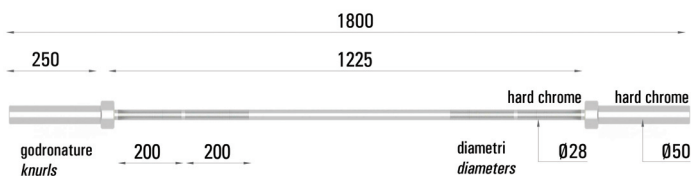

BILANCIERE POWER TRAINING 150**POWER TRAINING 150 BARBELL****cod. B0-150**

I - Bilanciere olimpico con finitura superficiale hard chromed. Carico max. statico 320 Kg. Lunghezza 150 cm. Lunghezza manicotti 25 cm. Peso 13 Kg. Diametro impugnatura 28 mm.

EN - Olympic hard chromed barbell - max static load 320 Kg. Lenght 150 cm. Sleeves lenght 25 cm. Weight 13 Kg. Grip dia 28 mm.

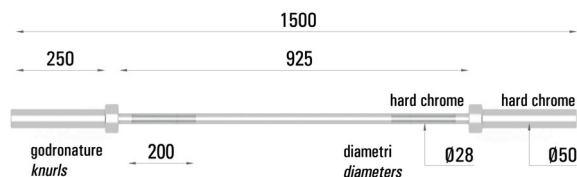
**BILANCIERE POWER TRAINING 120****POWER TRAINING 120 BARBELL****cod. BCO-120**

I - Bilanciere olimpico curl con finitura superficiale hard chromed. Carico max statico 300 Kg. Lunghezza 120 cm. Lunghezza manicotti 18 cm. Peso 9 Kg. Diametro impugnatura 28 mm.

EN - Olympic chromed EZ curl barbell - max static load 300 Kg. Lenght 120 cm. Sleeves lenght 18 cm. Weight 9 Kg. Grip dia 28 mm.

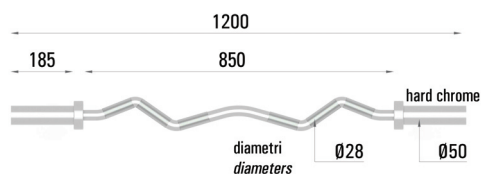

BILANCIERE POWER TRAINING 86**POWER TRAINING 86 BARBELL****cod. BCO-86**

I - Bilanciere olimpico multipresa finitura cromata. Carico max 300 Kg.
Lunghezza 86 cm. Lunghezza manicotti 17,5 cm. Peso 12 Kg. Diametro impugnatura 28 mm.

EN - Olympic chromed triceps barbell - max static load 300 Kg.
Lenght 86 cm. Sleevs length 17,5 cm. Weight 12 Kg. Grip dia 28 mm.

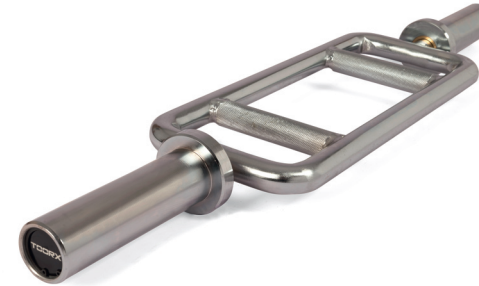
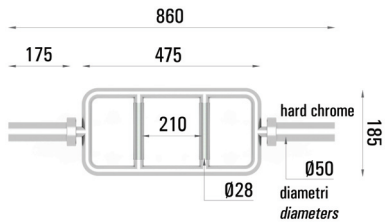
**MANUBRIO POWER TRAINING 51****POWER TRAINING 51 DUMBBELL****cod. MCO-51**

I - Manubrio olimpico caricabile finitura cromata con manicotti montati su bronzine
Lunghezza 51 cm. Lunghezza manicotti 16,5 cm. Peso 5 Kg. Diametro impugnatura 28 mm.

EN - Olympic chromed dumbbell 51 cm. with bronze bushings.
Lenght 51 cm. Sleevs lenght 16.5 cm. Weight 5 Kg. Grip dia 28 mm.

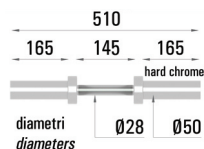

RASTRELLIERA PRO PORTA BILANCIERI DA TERRA **FLOOR BARBELLS RACK PRO**

cod. RPB-9PRO

I - Rastrelliera porta bilancieri olimpici da terra (9 posti) con boccole di protezione per i manicotti terminali.

Dimensioni: 43x43xH17,9 cm

*EN - Floor olympic barbells rack (9 places) with bushing for barbells sleeves.
Product size: 43x43xH17,9 cm*



RASTRELLIERA PORTA BILANCIERI DA TERRA **FLOOR BARBELLS RACK**

cod. RPB-9

I - Rastrelliera porta bilancieri olimpici da terra (9 posti) con boccole di protezione per i manicotti terminali.

Dimensioni: 42x57xH22 cm

*EN - Floor olympic barbells rack (9 places) with bushing for barbells sleeves.
Product size: 42x57xH22 cm*



RASTRELLIERA PORTA BILANCIERI A PARETE WALL BARBELLS RACK

cod. RBV-3PRO

I - Rastrelliera porta bilancieri olimpici a parete (3 posti) con inserti di protezione in HDPE.

EN - Wall olympic barbells rack (3 places) with HDPE protection pads.



Bilancieri non inclusi.
Barbells not included



RASTRELLIERA PORTA BILANCIERI A PARETE WALL BARBELLS RACK

cod. RPB-8

I - Rastrelliera porta bilancieri olimpici a parete (8 posti) con inserti di protezione in HDPE.

EN - Wall olympic barbells rack (8 places) with HDPE protection pads.



Bilancieri non inclusi.
Barbells not included

JERK BLOCKS IMPILABILI STACKABLE JERK BLOCKS

cod. AHF-274

I - Realizzati in legno di betulla multistrato. Impilabili. 2x40, 2x30, 2x15, 2x6 cm
Dimensioni 91 x 51 x H(40/30/15/6).

*EN - Made of birch plywood. Stackables. 2x40, 2x30, 2x15, 2x6 cm
Dimensions: 91 x 51 x H(40/30/15/6).*



COPPIA DI CUSCINI AMMORTIZZANTI DROP MATS DROP MATS

cod. AHF-257

I - Coppia di cuscini in grado di assorbire la caduta dei bilancieri, riducendo vibrazioni, rumore e impatto. Struttura interna in foam ad alta densità. Rivestimento in PVC.
Dimensione cuscino singolo 60x100xH18 cm.

EN - Shock mats able to absorb the barbells drops, reducing vibrations, noise and impact. Made of high density foam. PVC cover. Single mat dimensions 60x100xH18 cm



Dischi peso e bilanciere non inclusi.
Weight plates and barbell not included.

TOTAL CORE CON BASE**TOTAL CORE WITH BASE****cod. AHF-155**

I - Piattaforma con superficie inferiore gommata antiscivolo, perno rotante a 360° e doppio inserto per bilancieri ø25 / ø50 mm. Con impugnatura T-Bar.

EN - Platform with no slip rubber lower surface, 360° swivel and dual bar bracket to fit both ø25 / ø50 mm barbells. "T-bar" handles included.

**IMPUGNATURA T-BAR****T-BAR HANDLE****cod. AHF-280**

I - Impugnatura antiscivolo per una presa ottimale.

EN - Anti-slip handle for an optimal grip

**TOTAL CORE****cod. AHF-198**

I - Snodo girevole. Inserto per bilancieri ø 50 mm. Il perno deve essere ancorato ad uno o più dischi olimpici per garantire stabilità durante l'esercizio. Ideale per allenamento core.

EN - Swivel junction. Bar bracket suitable for ø 50 mm barbells. To be anchored to one or more olympic weight plates to guarantee stability during the use. Ideal for core training.



Dischi peso e bilanciere non inclusi.
Weight plates and barbell not included.

**CUSCINO DI PROTEZIONE BILANCIERE
PER HIP THRUST A CARICO LIBERO**
BARBELL PAD FOR FREE WEIGHT HIP THRUST

cod. CIP-HT

I - Realizzato con interno in cotone riciclato e copertura in tessuto PE impermeabile.

Dimensioni: 400 x ø180 mm.

EN - Made of recycled foam, PE waterproof cover.
Dimensions: 400 x ø180 mm.



**CUSCINO DI PROTEZIONE IN GOMMA PER
BILANCIERE E SQUAT**
RUBBER BARBELL/SQUAT PAD

cod. CIP-G

I - In gomma NBR e dotato di cinghietti di chiusura.

Dimensioni: 400 x ø80 mm.

EN - Made of NBR rubber. Clousure straps included.
Dimensions: 400 x ø80 mm.



**CUSCINO IMBOTTITO DI PROTEZIONE
PER BILANCIERE E SQUAT**
BARBELL/SQUAT PAD

cod. CIP

I - In gomma NBR rivestito in tessuto PE impermeabile

Dimensioni: 400 x ø80 mm.

EN - Made of NBR rubber with cover in waterproof PE.
Dimensions: 400 x ø80 mm.



CINTURE PER SOLLEVAMENTO PESI WEIGHTLIFTING BELTS

cod. CC-15S-M - misura S-M - size S-M

cod. CC-15L - misura L - size L

cod. CC-15XL - misura XL - size XL

I - Cintura in cuoio h. 15cm.

EN - Leather belt H. 15cm.



cod. CC-10S-M - misura S-M - size S-M

cod. CC-10L - misura L - size L

cod. CC-10XL - misura XL - size XL

I - Cintura in cuoio h. 10cm.

EN - Leather belt H. 10cm.



cod. CN-13,5

I - Cintura in nylon e neoprene h. 13,5cm e lunghezza 125cm con chiusura velcro misura unica

EN - Neoprene/nylon belt H. 13,5cm - L. 125cm with velcro lock system one size fits all



CINTURA PER DIP CON SOVRACCARICO DIP BELT

cod. DIP-B

I - Cintura in cordura di nylon. La fascia centrale imbottita da 10cm. ed il gancio di collegamento della catena ne aumentano il comfort d'utilizzo.

Dimensioni: 70 x H10 cm

EN - Nylon cordura belt. With central 10cm. padded band and a chain connection hook for high-comfort use.

Dimensions: 70 x H10 cm



GUANTI DI PROTEZIONE DEL PALMO 3 FORI
WEIGHTLIFTING PALMS WITH 3 HOLES

cod. **GPP3-S** - taglia S / size S

cod. **GPP3-M** - taglia M / size M

cod. **GPP3-L** - taglia L / size L

I - Paracalli con 3 fori e polsiera imbottita.

EN - Palm glove with 3 holes and padded wrist guard.

**GUANTI DI PROTEZIONE DEL PALMO IN PELLE**
LEATHER WEIGHTLIFTING PALMS

cod. **GPP**

I - Paracalli con polsiera imbottita.

EN - Palm glove with padded wrist guard.

**COPPIA AB STRAPS CINGHIE NYLON**
PER TRAZIONI

AB STRAPS - PULLING NYLON BELTS

cod. **AB-STRAPS**

I - Coppia di fasce in nylon per l'allenamento in sospensione del core.

EN - Nylon bands for core suspension training.



COPPIA FERMA DISCHI IN ALLUMINIO PAIR OF ALUMINIUM SAFETY COLLARS

cod. CFA

I - Coppia ferma dischi in alluminio con pad interno antiscivolo color alluminio.

EN - Pair of aluminium safety collars with inner anti-slip pad aluminium colour.



COPPIA FERMA DISCHI IN ALLUMINIO PAIR OF ALUMINIUM SAFETY COLLARS

cod. CFAO

I - Coppia ferma dischi in alluminio con pad interno antiscivolo color oro.

EN - Pair of aluminium safety collars with inner anti-slip pad gold colour.



COPPIA FERMA DISCHI IN NYLON PAIR OF NYLON SAFETY COLLARS

cod. CFSL

I - Coppia ferma dischi SAFE LOCK – colore NERO

EN - Pair of collars SAFE LOCK – colour BLACK



COPPIA FERMA DISCHI IN NYLON PAIR OF NYLON SAFETY COLLARS

cod. CFSL-R

I - Coppia ferma dischi SAFE LOCK – colore ROSSO

EN - Pair of collars SAFE LOCK – colour RED



COPPIA FERMA DISCHI A MOLLA PAIR OF SPRING CLIP SAFETY COLLARS

cod. CFBS

I - Coppia ferma dischi a molla impugnatura big size.

EN - Pair of spring clip safety collars - big size grip.



MAGNESITE IN PANI CHALK BLOCKS

cod. AHF-185

I - Ideale per gli allenamenti funzionali, ginnastica artistica, crosstraining e arrampicata sportiva. Disponibile in confezioni da 8 pani da 56 gr.

EN - Ideal for functional, gymnastic, crosstraining and climbing training. 8 blocks 56 gr each in a colour box.





02

ACCESSORI - ACCESSORIES 2024

ATTACHMENTS

ATTACHMENTS ABSOLUTE

I - Struttura in tubolare d'acciaio e manicotto di rotazione interamente cromati per garantire scorrevolezza e protezione dall'ossidazione. Rivestita in gomma vergine per salvaguardare gli attrezzi e dotata di terminali in alluminio. Diametro impugnatura 32 mm.

EN - Steel tube and rotating joint fully chromed to allow a smooth rotation and rusty-proof. Rubber coated handle to protect the painting. Tube ends with alu caps. Handle diameter 32 mm.

BARRA BICIPITI GOMMATA ABSOLUTE RUBBER COATED BIICEPS BAR ABSOLUTE

cod. BBG-53.5

I - Diametro impugnatura 32 mm. Lunghezza 53,5 cm.

EN - Handle diameter 32 mm. Length 53,5 cm.



BARRA LAT GOMMATA ABSOLUTE RUBBER COATED LAT BAR ABSOLUTE

cod. BLG-120

I - Diametro impugnatura 32 mm. Lunghezza 120 cm.

EN - Handle diameter 32 mm. Length 120 cm.



BARRA TRAZIONI GOMMATA ABSOLUTE RUBBER COATED TRACY BAR ABSOLUTE

cod. BTG-88

I - Diametro impugnatura 32 mm. Lunghezza 88 cm.

EN - Handle diameter 32 mm. Length 88 cm.



BARRA MULTIGRIP GOMMATA ABSOLUTE
RUBBER COATED MULTIGRIP BAR ABSOLUTE

cod. BMG-72.5

I - Diametro impugnatura 32 mm. Lunghezza 72,5 cm.

EN - Handle diameter 32 mm. Length 72,5 cm.



BARRA TRICIPITI GOMMATA ABSOLUTE
RUBBER COATED TRICEPS BAR ABSOLUTE

cod. BTG-61

I - Diametro impugnatura 32 mm. Lunghezza 61 cm.

EN - Handle diameter 32 mm. Length 61 cm.



BARRA TRICIPITI ANGOLATA GOMMATA ABSOLUTE
RUBBER COATED REVOLVING TRICEPS BAR ABSOLUTE

cod. BTAG-28.3

I - Diametro impugnatura 32 mm. Lunghezza 28,3 cm.

EN - Handle diameter 32 mm. Length 28,3 cm.



MANIGLIA SINGOLA ABSOLUTE
SINGLE HANDLE ABSOLUTE

cod. MS-PRO

I - Struttura in ABS ed impugnatura rotante.

EN - ABS structure and rotating handle.



MANIGLIA DOPPIA ABSOLUTE
DOUBLE HANDLE ABSOLUTE

cod. MD-PRO

I - Struttura in ABS.

EN - ABS structure



**BARRA LAT CON PRESA A MARTELLLO
IN DIPPING**

DIPPING LAT BAR WITH HAMMER GRIP

cod. BL-80

I - Lunghezza 80 cm.

EN - Length 80 cm.



**BARRA LAT CON PRESA DIVERGENTE
A MARTELLLO IN DIPPING**

DIPPING LAT BAR WITH DIVERGING HAMMER GRIP

cod. BLD-58

I - Lunghezza 58 cm.

EN - Length 58 cm.



**BARRA LAT CON PRESA CONVERGENTE
A MARTELLLO IN DIPPING**

DIPPING LAT BAR WITH CONVERGING HAMMER GRIP

cod. BLC-60

I - Lunghezza 60 cm.

EN - Length 60 cm.



**DOPPIA IMPUGNATURA CON PRESA
A MARTELLLO IN DIPPING**

DIPPING DOUBLE HANDLE WITH HAMMER GRIP

cod. DI-33

I - Lunghezza 33 cm.

EN - Length 33 cm.



cod. DI-31.5

I - Lunghezza 31,5 cm.

EN - Length 31,5 cm.



BARRE E IMPUGNATURE IN DIPPING - SET 5 PZ

DIPPING BARS AND GRIPS - SET 5 PCS

cod. BID-SET5

I - Impugnatura gommata con processo "dipping" ad immersione. Anima in acciaio.

EN - Rubberized handle with dipping process. Inner structure in steel.



**RASTRELLIERA PER BARRE ED IMPUGNATURE
IN DIPPING DA TERRA**

DIPPING BARS AND GRIPS RACK

cod. RBI-5

I - Rastrelliera da terra a 5 posti per impugnature in dipping

EN - 5 places floor rack for dipping handles



BARRA LAT 122 cm - CON 6 IMPUGNATURE

LAT BAR 122 cm - WITH 6 HANDLES

cod. BL-122N



BARRA LAT 91 cm - CON 4 IMPUGNATURE

LAT BAR 91 cm - WITH 4 HANDLES

cod. BL-91



BARRA LAT 96,5 cm - CON 2 MANIGLIE

PULL DOWN BAR 96,5 cm - WITH 2 HANDLES

cod. BL-96,5



BARRA LAT 61 cm - CON 2 MANIGLIE
PULL DOWN BAR 61 cm - WITH 2 HANDLES

cod. BL-61N



BARRA MULTI ESERCIZI
MULTI EXERCISE BAR

cod. BME



BARRA TRICIPITI DRITTA
STRAIGHT TRICEPS BAR

cod. BTDN



BARRA TRICIPITI REVOLVING
REVOLVING TRICEPS BAR

cod. BTR



BARRA TRICIPITI ANGOLATA
TRICEPS PRESS DOWN BAR

cod. BTN



MANIGLIA DOPPIA PULLEY
CABLE ATTACHMENT DOUBLE HAND

cod. MDN



MANIGLIA SINGOLA PULLEY
CABLE ATTACHMENT SINGLE HAND

cod. MSN



CORDA DOPPIA PER TRICIPITI
TRICEPS ROPE

cod. CDTNN

I - Lunghezza 85 cm.

EN - Length 85 cm.



CORDA SINGOLA PER TRICIPITI / TRAZIONI
TRICEPS ROPE SINGLE

cod. CSTN



COPPIA POLSIERA PER TRAZIONI CON ANELLO E CHIUSURA VELCRO
PULLING WRIST CUFFS WITH RING AND VELCRO LOCK SYSTEM

cod. POL-TA



COPPIA CAVIGLIERA PER TRAZIONI CON ANELLO E CHIUSURA VELCRO
PULLING ANKLE CUFFS WITH RING AND VELCRO LOCK SYSTEM

cod. CAV-TA



ACCESSORIO LAT MACHINE
LAT MACHINE ACCESSORY

cod. AGU-LM

I - Cavo d'acciaio rivestito in PVC, con sfera di gravità. In dotazione corda di trazione, barra dritta, adattatore per dischi peso con foro ø50mm e moschettone di fissaggio.

Peso massimo caricabile 100 kg.

EN - PVC coated steel cable, with gravity ball. Supplied with traction rope, straight bar, adapter for weight plates with ø50mm hole and fixing carabiner. Maximum loadable weight 100 kg.





03

ACCESSORI - ACCESSORIES 2024

FUNCTIONAL

POWER BAGS ABSOLUTE

I - Sacca appesantita con 6 impugnature. Rivestimento Carbon look ad alta resistenza alla trazione. Cuciture a rinforzate. Strap in cordura di nylon con impugnature imbottite. Dimensione: 56xø22 cm.

EN - Weighted bag with 6 handles. Carbon look coating with high tensile strength. Reinforced stitching. Cordura nylon handles with padded grips. Dimension: 56xø22 cm.

cod. APBG-5 - Kg. 5
 cod. APBG-10 - Kg. 10
 cod. APBG-15 - Kg. 15

cod. APBG-20 - Kg. 20
 cod. APBG-25 - Kg. 25



POWER BAGS

I - Sacca appesantita con 6 impugnature. Il peso discrimina il diverso colore delle finiture. Cuciture rinforzate. Strap in cordura di nylon con impugnature in PE. Dimensione: 56xø22 cm

EN - Weighted bag with 6 handles. The weight indicates the different color of the finishes. Reinforced stitching. Cordura nylon handles with PE grips. Dimension: 56xø22 cm

cod. PBG-5N - Kg. 5
 cod. PBG-10N - Kg.10
 cod. PBG-15N - Kg. 15

cod. PBG-20N - Kg. 20
 cod. PBG-25N - Kg. 25



WATER BAG

cod. WBG

I - Sacca in PVC trasparente vulcanizzato per allenamento funzionale, con 4 maniglie. Coloranti per acqua inclusi - verde, rosso e blu. Capienza massima 25 kg. Pompa inclusa. Tappo di sicurezza.
Dimensione: 90xø27 cm

*EN - Vulcanized transparent PVC bag for functional training, with 4 handles. Water dyes included - green, red and blue. Maximum capacity 25 kg. Pump included. Safety cap.
Dimension: 90xø27 cm*



RASTRELLIERA PORTA POWER BAG POWER BAGS RACK

cod. RPF-B5

I - Rastrelliera porta power bag (5 posti). Struttura verticale, 5 postazioni di stoccaggio inclinate per prevenire la caduta accidentale.
Dimensioni: 68x66xH148,5 cm

*EN - Power bag rack (5 places). Vertical structure, 5 inclined storage stations to prevent accidental falls.
Dimensions: 68x66xH148,5 cm*



KETTLEBELL COMPETITION ABSOLUTE

COMPETITION KETTLEBELL ABSOLUTE

I - Kettlebell disegno olimpico in acciaio. Identico volume, diversi tagli di peso, corpo verniciato a fuoco con collari di colore diverso in base al peso. Dotati di sagomature per una presa più confortevole.

EN - Kettlebell Olympic design made of steel. Same volume, different weights, stove-painted body with different color collars based on size. With body shaping for a more comfortable grip.

cod. **AKCA-8** - Kg. 8
 cod. **AKCA-10** - Kg. 10
 cod. **AKCA-12** - Kg. 12
 cod. **AKCA-14** - Kg. 14

cod. **AKCA-16** - Kg. 16
 cod. **AKCA-18** - Kg. 18
 cod. **AKCA-20** - Kg. 20
 cod. **AKCA-24** - Kg. 24

cod. **AKCA-28** - Kg. 28
 cod. **AKCA-32** - Kg. 32
 cod. **AKCA-36** - Kg. 36



KETTLEBELL OLIMPICHE EVO

OLYMPIC EVO KETTLEBELL

I - Kettlebell disegno olimpico in acciaio. Identico volume, diversi tagli di peso, impugnatura cromata. Colorazione del corpo sferico differenziata per pezzatura.

EN - Kettlebell Olympic design made of steel. Same volume, different weights, chromed handle. Spherical body colours, depending on size.

cod. **KCAE-8** - Kg. 8
 cod. **KCAE-10** - Kg. 10
 cod. **KCAE-12** - Kg. 12
 cod. **KCAE-14** - Kg. 14

cod. **KCAE-16** - Kg. 16
 cod. **KCAE-18** - Kg. 18
 cod. **KCAE-20** - Kg. 20
 cod. **KCAE-24** - Kg. 24

cod. **KCAE-28** - Kg. 28
 cod. **KCAE-32** - Kg. 32



KETTLEBELL PRO CROSS EVO PRO CROSS EVO KETTLEBELL

I - Kettlebell verniciato a fuoco, il corpo sferico cresce di volume in proporzione al peso. Finitura full black con collari di colore diverso, in base al peso.

EN - Stove-painted kettlebell, the spherical body grows in volume in proportion to the weight. Full black finish with different colored collars, depending on size

- | | |
|-----------------------|-----------------------|
| cod. KPCE-4 - Kg. 4 | cod. KPCE-24 - Kg. 24 |
| cod. KPCE-6 - Kg. 6 | cod. KPCE-28 - Kg. 28 |
| cod. KPCE-8 - Kg. 8 | cod. KPCE-32 - Kg. 32 |
| cod. KPCE-10 - Kg. 10 | cod. KPCE-36 - Kg. 36 |
| cod. KPCE-12 - Kg. 12 | cod. KPCE-40 - Kg. 40 |
| cod. KPCE-16 - Kg. 16 | |
| cod. KPCE-20 - Kg. 20 | |



KETTLEBELL VINILE VINYL COATED KETTLEBELL

I - Kettlebell rivestita in vinile colorato in base al peso. Ideali per pavimentazioni delicate e prive di rivestimento. Impugnature verniciate con finitura martellata.

EN - Vinyl kettlebell colored according to the size. Ideal for delicat uncoated floors (parquet). Painted handles with hammered finish.

- | | |
|----------------------|----------------------|
| cod. KRV-2 - Kg. 2 | cod. KRV-16 - Kg. 16 |
| cod. KRV-4 - Kg. 4 | cod. KRV-18 - Kg. 18 |
| cod. KRV-6 - Kg. 6 | cod. KRV-20 - Kg. 20 |
| cod. KRV-8 - Kg. 8 | cod. KRV-24 - Kg. 24 |
| cod. KRV-10 - Kg. 10 | |
| cod. KRV-12 - Kg. 12 | |
| cod. KRV-14 - Kg. 14 | |



KETTLEBELL BOWFLEX SELECTECH 840



cod. BOW-840

I - Kettlebell a carico variabile con set di 6 pesi a selezione rapida. Dimensione kettlebell 22,5 x 18 x 32 cm. Diametro manico 28 mm con impugnatura ergonomica multi-presa. Peso regolabile da 3,5 a 18 kg. Selezionatore dei pesi: 3,5 - 5,5 - 9 - 11 - 16 - 18 kg. Pratica base di appoggio con superficie antiscivolo. Disponibili 24 video di allenamento gratuiti.

EN - Adjustable selective kettlebell with 6 weight plates set. Kettlebell size 22,5 x 18 x 32 cm Handle diameter 28 mm with ergonomic - multi-grip. Adjustable weight from 3,5 to 18 kg. Selectable weight plates : 3,5 - 5,5 - 9 - 11 - 16 - 18 kg. Handy support base with non-slip surface. 24 free training videos available.



WALL BALLS ABSOLUTE

I - Wall Ball con rivestimento Carbon look, antiscivolo. Grande resistenza alla deformazione e strappo. Cuciture rinforzate. Il colore identifica i diversi tagli peso. Diametro 35 cm.

EN - Wall Ball with Carbon look, non-slip coating. High resistance to deformation and tearing. Reinforced stitching. The different color monogram identifies the different weights. Diameter 35 cm.

cod. AHF-204 - ø 35 cm Kg. 3 cod. AHF-208 - ø 35 cm Kg. 7 cod. AHF-212 - ø 35 cm Kg. 12
 cod. AHF-205 - ø 35 cm Kg. 4 cod. AHF-209 - ø 35 cm Kg. 8 cod. AHF-262 - ø 35 cm Kg. 15
 cod. AHF-206 - ø 35 cm Kg. 5 cod. AHF-210 - ø 35 cm Kg. 9
 cod. AHF-207 - ø 35 cm Kg. 6 cod. AHF-211 - ø 35 cm Kg. 10



WALL BALLS

I - Wall Ball con rivestimento colorato a seconda del peso. Alta resistenza a deformazione e strappo. Cuciture rinforzate. Diametro 35 cm.

EN - Wall Ball with colored coating depending on weight. High resistance to deformation and tearing. Reinforced stitching. Diameter 35 cm.

cod. AHF-224 - ø 35 cm Kg. 3 cod. AHF-228 - ø 35 cm Kg. 7 cod. AHF-232 - ø 35 cm Kg. 12
 cod. AHF-225 - ø 35 cm Kg. 4 cod. AHF-229 - ø 35 cm Kg. 8 cod. AHF-263 - ø 35 cm Kg. 15
 cod. AHF-226 - ø 35 cm Kg. 5 cod. AHF-230 - ø 35 cm Kg. 9
 cod. AHF-227 - ø 35 cm Kg. 6 cod. AHF-231 - ø 35 cm Kg. 10

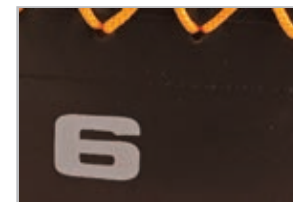

SLAM BALLS ABSOLUTE

I - Slam Ball con rivestimento Tyre look, antiscivolo, di grande spessore. Ottima resistenza all'abrasione. Indicazione del peso in campo colorato, per una facile identificazione.

EN - Slam Ball with Tyre look coating, non-slip, very thick. Excellent abrasion resistance. Weight indication in colored field, for easy identification.

cod. AHF-213 - ø 23 cm Kg. 2	cod. AHF-218 - ø 23 cm Kg. 7	cod. AHF-223 - ø 28 cm Kg. 15
cod. AHF-214 - ø 23 cm Kg. 3	cod. AHF-219 - ø 23 cm Kg. 8	cod. AHF-252 - ø 28 cm Kg. 20
cod. AHF-215 - ø 23 cm Kg. 4	cod. AHF-220 - ø 23 cm Kg. 9	cod. AHF-253 - ø 28 cm Kg. 25
cod. AHF-216 - ø 23 cm Kg. 5	cod. AHF-221 - ø 23 cm Kg. 10	cod. AHF-254 - ø 28 cm Kg. 30
cod. AHF-217 - ø 23 cm Kg. 6	cod. AHF-222 - ø 28 cm Kg. 12	



SLAM BALLS

I - Slam Ball con rivestimento full black antiscivolo. Alta resistenza all'abrasione.

EN - Slam Ball with full black non-slip coating. High abrasion resistance.

cod. AHF-048 - ø 23 cm Kg. 2	cod. AHF-052 - ø 23 cm Kg. 6	cod. AHF-056 - ø 23 cm Kg. 10
cod. AHF-049 - ø 23 cm Kg. 3	cod. AHF-053 - ø 23 cm Kg. 7	cod. AHF-096 - ø 28 cm Kg. 12
cod. AHF-050 - ø 23 cm Kg. 4	cod. AHF-054 - ø 23 cm Kg. 8	cod. AHF-097 - ø 28 cm Kg. 15
cod. AHF-051 - ø 23 cm Kg. 5	cod. AHF-055 - ø 23 cm Kg. 9	

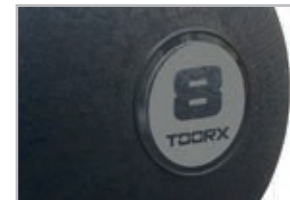

PALLE MEDICHE CON MANIGLIE ABSOLUTE
MEDICINE BALLS WITH HANDLES ABSOLUTE

I - Med Ball con rivestimento full black con doppia maniglia antiscivolo. Alta resistenza all'abrasione. Indicazione del peso in campo colorato, per una facile identificazione.

EN - Med Ball with full black covering with double non-slip handle. High abrasion resistance. Weight indication in colored field, for easy identification.

- | | |
|---------------------------------------|--|
| cod. AHF-176 - ø 23 cm Kg. 3 | cod. AHF-180 - ø 27,2 cm Kg. 7 |
| cod. AHF-177 - ø 23 cm Kg. 4 | cod. AHF-181 - ø 27,2 cm Kg. 8 |
| cod. AHF-178 - ø 27,2 cm Kg. 5 | cod. AHF-260 - ø 27,2 cm Kg. 9 |
| cod. AHF-179 - ø 27,2 cm Kg. 6 | cod. AHF-261 - ø 27,2 cm Kg. 10 |



PALLE MEDICHE
MEDICINE BALLS

I - Med Ball con rivestimento Full Black. Indicazione del peso colorata, per una facile identificazione.

EN - Med Ball with Full Black coating. Colored weight indication for easy identification.

- | | |
|-------------------------------------|---------------------------------------|
| cod. AHF-105 - ø 23 cm Kg. 1 | cod. AHF-108 - ø 23 cm Kg. 4 |
| cod. AHF-106 - ø 23 cm Kg. 2 | cod. AHF-109 - ø 28,6 cm Kg. 5 |
| cod. AHF-107 - ø 23 cm Kg. 3 | cod. AHF-110 - ø 28,6 cm Kg. 6 |



RASTRELLIERA PRO PORTA KETTLEBELL/PALLE MEDICHE KETTLEBELLS/MEDICINE BALLS RACK PRO

cod. RPM-B2R

I - Rastrelliera porta Kettlebell/palle mediche a 2 ripiani, con pad di protezione antiscivolo. I piedi in gomma prevengono sia lo scivolamento che il danneggiamento del pavimento.
Dimensioni : 120x60xH77 cm

EN - Kettlebell/medicine ball rack with 2 shelves, with non-slip protection pad. The rubber feet prevent both slipping and floor damaging.
Dimensions: 120x60xH77 cm



RASTRELLIERA VERTICALE PORTA KETTLEBELL /PALLE MEDICHE VERTICAL KETTLEBELLS/MEDICINE BALLS RACK

cod. RPK-B8

I - Rastrelliera verticale porta Kettlebell/palle mediche a ripiani (8 posti). I 4 piedi in gomma prevengono sia lo scivolamento che il danneggiamento del pavimento.
Dimensioni: 45x53xH128 cm

EN - Vertical Kettlebell/medicine ball rack with shelves (8 places). The 4 rubber feet prevent both slipping and damage to the floor.
Dimensions: 45x53xH128 cm



**FUNE DA ALLENAMENTO
HIGH PERFORMANCE
HIGH PERFORMANCE BATTLE ROPE**

cod. BR-3812-PRO - ø 38 mm x 12 mt

I - Fune in poliestere lavorata a treccia con anima interna e finitura soft touch. Impugnature rivestite in gomma termoretraibile. Ideale per il potenziamento dei muscoli di spalle, braccia e core. Perfetto strumento negli allenamenti HIIT rappresentando una delle stazioni a più alta intensità aerobica ed anaerobica.

Dimensioni: ø 38 mm x 12 mt

EN - Polyester encased rope with inner core with soft touch finishing. Shrinkwrap handles. Ideal for strengthening shoulder, arm and core muscles. Perfect tool for HIIT workouts, it is one of the stations with the highest aerobic and anaerobic intensity.

Dimensions: ø 38 mm x 12 mt



**FUNE DA ALLENAMENTO
CON GUAINA IN NYLON
BATTLE ROPE WITH NYLON SHEATH**

I - Fune in poliestere intrecciato rivestita con guaina in nylon. Impugnature rivestite in gomma termoretraibile. Ideale per il potenziamento dei muscoli di spalle, braccia e core. Perfetto strumento negli allenamenti HIIT rappresentando una delle stazioni a più alta intensità aerobica ed anaerobica.

Dimensioni: ø 38 mm x 12 mt e ø 50 mm x 15 mt.

EN - Polyester encased rope with nylon sheath. Shrink-wrap handles. Ideal for strengthening shoulder, arm and core muscles. Perfect tool for HIIT workouts, it is one of the stations with the highest aerobic and anaerobic intensity.

Dimensions : ø 38 mm x 12 mt and ø 50 mm x 15 mt.

cod. BR-3812G - ø 38 mm x 12 mt

cod. BR-5015G - ø 50 mm x 15 mt



**FUNE DA ALLENAMENTO
BATTLE ROPE**

I - Fune in poliestere intrecciato con impugnature rivestite in gomma termoretraibile. Ideale per il potenziamento dei muscoli di spalle, braccia e core. Perfetto strumento negli allenamenti HIIT rappresentando una delle stazioni a più alta intensità aerobica ed anaerobica.

Dimensioni: ø 38 mm x 12 mt e ø 50 mm x 15 mt.

EN - Polyester encased rope with shrinkwrap handles. Ideal for strengthening shoulder, arm and core muscles. Perfect tool for HIIT workouts, it is one of the stations with the highest aerobic and anaerobic intensity.

Dimensions : ø 38 mm x 12 mt e ø 50 mm x 15 mt.

cod. BR-3812 - ø 38 mm x 12 mt

cod. BR-5015 - ø 50 mm x 15 mt



FUNE DA ARRAMPICATA
CLIMBING ROPE

cod. AHF-153

I - Fune in canapa intrecciata. Impugnature rivestite in gomma termoretraibile. Ideale per il potenziamento dei muscoli di spalle e avambracci. Ottimo allenamento di coordinazione neuromotoria. Dimensione : ø 38 mm x 5 mt.

EN - Manila hemp encased rope with shrinkwrap handles. Ideal for strengthening shoulder, arm and core muscles. Excellent tool for neuromotor coordination training. Dimensions : ø 38 mm x 5 mt.



ANELLO DI ANCORAGGIO PER FUNI DA ALLENAMENTO
ANCHOR RING FOR BATTLE ROPES

cod. AA-BR

I - Anello di ancoraggio in acciaio adatto a funi con ø 38 mm e ø 50 mm. Indispensabile per effettuare esercizi di oscillazione con una sola fune.

EN - Steel anchor ring suitable for ø 38 mm and ø 50 mm ropes. Essential for wave exercises.



COPPIA POLSIERA CON GANCIO
CLAWS LIFTING HOOKS

cod. CP-GAN

I - Polsiera in cordura di Nylon, regolazione del serraggio con velcro di grande dimensione. Gancio in Acciaio completamente fissato alla polsiera in modo da prevenire dislocazioni accidentali.

EN - Nylon cordura wristband, tightening adjustment with large velcro. Steel hook completely fixed to the wrist guard to prevent accidental dislocations.



COPPIA CAVIGLIERE ANTIGRAVITAZIONALI
INVERSION BOOTS

cod. CCAN

I - Cavigliera realizzata in acciaio con gancio di serraggio a scatto. Imbottitura interna per una migliore aderenza e protezione dell'arto.

EN - Boots made of steel with snap fastening hook. Internal padding for better grip and protection of the limb.



FASCE PER WEIGHTLIFTING CON ANELLO WEIGHTLIFTING BANDS WITH THUMB LOOP

cod. FWLA

I - Supporti a fascia da polso, offrono una presa salda sul bilanciere garantendo il massimo confort. Ideate per prevenire infortuni in condizioni di carico pesante. Dotate di anello per una maggiore sicurezza e per conferire il massimo feeling durante l'allenamento

EN - Wrist band supports, offer a firm grip on the barbell ensuring maximum comfort. Designed to prevent injuries in heavy load conditions. Equipped with thumb loop for greater safety and to give maximum feeling during the workout



FASCE PER WEIGHTLIFTING WEIGHTLIFTING BANDS

cod. FWL

I - Supporti a fascia da polso, offrono una presa salda sul bilanciere garantendo il massimo confort. Ideate per prevenire infortuni in condizioni di carico pesante.

EN - Wrist band supports, offer a firm grip on the barbell ensuring maximum comfort. Designed to prevent injuries in heavy load conditions.



TRALICCIO TRAZIONI MULTIPRESA PRO CON FISSAGGIO A PARETE **WALL MOUNTED BAR PRO WITH MULTIPLE HANDLES**

cod. TTM-PRO

I - Robusto traliccio con fissaggio a parete, ideale per l'allenamento a corpo libero od in sospensione. Finitura cromatica speciale per una presa ottimale.

Barra di trazione in tubolare rinforzato a sezione tonda \varnothing 30 mm.

Supporti in scatolato quadro rinforzato da 50x50 mm.

Dimensioni: 1180x660x530 mm.

Peso max utilizzatore: 150 Kg.

***EN** - Sturdy and versatile professional wall mounted bar, ideal for bodyweight workout.*

Special painting for a perfect grip.

Pull bar round heavy-duty steel tubing \varnothing 30 mm.

Square heavy-duty steel tubing 50x50 mm.

Product dimensions: 1180x660x530 mm.

Max user weight: 150 Kg



BARRA TRAZIONI PRO CON FISSAGGIO A PARETE **WALL MOUNTED BAR PRO**

cod. BT-PRO

I - Robusta barra con fissaggio a parete, ideale per esercizi di pull-up e muscle-up. Finitura cromatica speciale per una presa ottimale.

Barra di trazione in tubolare rinforzato a sezione tonda \varnothing 30 mm

Supporti in scatolato quadro rinforzato da 50x50 mm.

Distanza dal muro 90 cm.

Dimensioni: 1100x950x600 mm.

***EN** - Sturdy and versatile wall mounted bar, ideal for pull-up and muscle-up workout.*

Special painting for a perfect grip.

Pull-up bar round heavy-duty steel tubing \varnothing 30 mm

Square heavy-duty steel tubing 50x50 mm.

Distance from wall 90 cm.

Product dimensions 1100x950x600 mm.



GILET CON PESI 30 KG
SAND VEST 30 KG

cod. AHF-113

I - Taglia unica - regolabile con velcro di grandi dimensioni. 30 sacchetti/peso, estraibili, da 1 Kg cad. Aumenta l'intensità dell'allenamento, personalizza il sovraccarico mantenendolo in linea con il baricentro.

EN - One size fits all - adjustable with straps. 30 removable ironfilled weight bags - 1Kg each. Increase the intensity of the training, customize the overload while keeping it in line with the center of gravity.



GILET CON PESI 20 KG
SAND VEST 20 KG

cod. AHF-112

I - Taglia unica - regolabile con velcro di grandi dimensioni. 20 sacchetti/peso, estraibili, da 1 Kg cad. Aumenta l'intensità dell'allenamento, personalizza il sovraccarico mantenendolo in linea con il baricentro.

EN - One size fits all - adjustable with straps. 20 removable iron-filled weight bags - 1Kg each. Increase the intensity of the training, customize the overload while keeping it in line with the center of gravity.



GILET CON PESI 10 KG SAND VEST 10 KG

cod. AHF-014

I - Taglia unica - regolabile con velcro di grandi dimensioni. 10 sacchetti/peso, estraibili, da 1 Kg cad. Aumenta l'intensità dell'allenamento, personalizza il sovraccarico mantenendolo in linea con il baricentro.

EN - One size fits all - adjustable with straps. 20 removable iron-filled weight bags - 1Kg each. Increase the intensity of the training, customize the overload while keeping it in line with the center of gravity.



GILET CON PESI TACTICAL 15 KG TACTICAL WEIGHTED VEST 15 KG

cod. AHF-190

I - L'innovativo gilet, realizzato in nylon 600D ultra resistente, traspirante e impermeabile nasce dall'esperienza militare. Dotato di due alloggiamenti per piastre, nella parte anteriore e posteriore. È possibile caricare un massimo di 4 piastre per ogni gilet Tactical. Aumenta l'intensità dell'allenamento, personalizza il sovraccarico mantenendolo in linea con il baricentro.

Coppia di piastre in acciaio da 2,6 kg cad. incluse - dimensioni 320x220x5mm.

Coppia di piastre in acciaio da 4 kg cad. incluse - dimensioni 320x220x8mm.

EN - From military experience, the uniquely designed tactical vest made from an ultra-durable, breathable and water resistant 600D nylon. Plates compartments on front and back vest sides. Increase the intensity of the training, customize the overload while keeping it in line with the center of gravity. Each tactical vest can contain up to 4 plates.

2 steel plates 2,6 kg each. included - dimensions 320x220x5mm.

2 steel plates 4 kg each. included - dimensions 320x220x8mm.



FUNCTIONAL SUSPENSION WORKOUT PRO

cod. FST-PRO

I - Sistema di cinghie per allenamento in sospensione. Pratico e versatile, coinvolge tutti i gruppi muscolari. Con maniglie vincolate all'anello. Dotato di safe-locking system per una regolazione immediata e sicura delle cinghie e un'aderenza perfetta a polso e caviglia. Moschettoni in acciaio.

EN - Strap system for suspension training. Practical and versatile, it involves all muscle groups. Handles joined to the ring. Safe-locking system for an easy and safe handle adjustment. Steel snap-hooks.



FUNCTIONAL SUSPENSION WORKOUT DOUBLE PRO

cod. FST-DOUBLE

I - Sistema professionale di cinghie per allenamento in sospensione. Pratico e versatile, coinvolge tutti i gruppi muscolari. Con maniglie svincolate dall'anello. Dotato di safe-locking system per una regolazione immediata e sicura delle cinghie e un'aderenza perfetta a polso e caviglia. Moschettoni ed anello in acciaio.

EN - Strap system for suspension training. Practical and versatile, it involves all muscle groups. Free handles to be used also separately. Safe-locking system for an easy and safe handle adjustment. Steel snap-hooks and ring.



ANELLO DOPPIO DI ANCORAGGIO PER FST DOUBLE RING ANCHOR FOR FST

cod. AA-FST

I - Supporto a doppio anello incrociato, a parete o soffitto, per sistemi di allenamento in sospensione, rigidi od elastici. Interamente in acciaio verniciato, con due fori di fissaggio. Diametro 12 cm

EN - Double crossed ring support, wall or ceiling, for suspension training systems, rigid or elastic. Entirely in painted steel, with two fixing holescod. Diameter 12 cm



COPPIA DI ANELLI IN LEGNO PER FST DOUBLE PRO WOODEN GYM RINGS FOR FST DOUBLE PRO

cod. CAGL-FST

I - Coppia di anelli da ginnastica in legno di faggio con cinghia per la regolazione dell'altezza da terra. Complemento ideale per il FUNCTIONAL SUSPENSION Workout DOUBLE PRO

EN - Beech wood gym rings with belt for adjusting the height from the ground. Suitable for FUNCTIONAL SUSPENSION Workout DOUBLE PRO



COPPIA ANELLI DA GINNASTICA IN LEGNO WOODEN GYM RINGS

cod. CAGL

I - Coppia di anelli da ginnastica in legno di faggio con cinghia numerata per la regolazione dell'altezza da terra

EN - Beech wood gym rings set with numbered strap for adjusting the height from the ground



COPPIA ANELLI DA GINNASTICA GYM RINGS SET

cod. CAG

I - Coppia di anelli da ginnastica in legno di faggio con cinghia numerata per la regolazione dell'altezza da terra

EN - Beech wood gym rings set with numbered strap for adjusting the height from the ground



COPPIA DI PARALLETTES H 75 CM

PARALLELS H 75 CM

cod. AHF-161

I - Parallele per l'allenamento funzionale e la callistenia realizzati interamente in metallo per una stabilità ottimale. Ideali per il potenziamento muscolare di braccia, torace, schiena, addome e core.

Dimensioni : 36x60xH75 cm

EN - Parallels for functional training and calisthenics. Entirely made of metal for optimal stability. Tones and strengthens arms, chest, back, abdominals and core.

Dimensions: 36x60xH75 cm



COPPIA DI MINI PARALLETTES H 35 CM

MINI PARALLELS H 35 CM

cod. AHF-160

I - Parallele per l'allenamento funzionale e la callistenia realizzati interamente in metallo per una stabilità ottimale. Ideali per il potenziamento muscolare di braccia, torace, schiena, addome e core.

Dimensioni : 36x60xH35 cm

EN - Parallels for functional training and calisthenics. Entirely made of metal for optimal stability. Tones and strengthens arms, chest, back, abdominals and core.

Dimensions: 36x60xH35 cm



SET DI 3 SOFT PLYO BOX IMPILABILI

SET OF 3 STACKABLE SOFT PLYO BOXES

cod. AHF-256

I - Set composto da 3 plyo box soft, di dimensioni diverse, impilabili, per esercizi pliometrici. Struttura in polietilene espanso, rivestimento in PVC. Bordi stondati, per limitare le conseguenze degli urti. Dotati di cerniera, 2 maniglie di trasporto e strap con velcro per fissaggio in colonna.

Dimensioni: 90x73xH30, 90x73xH45, 90x73xH60 cm

Peso 24 kg

EN - Set of 3 stackable soft plyo boxes with different sizes, stackable for plyometric exercises. Made of expanded polyethylene filling and PVC cover. Rounded edges to decrease impact consequences. With zip, 2 moving handles and straps with velcro for column fixing.

Dimensions: 90x73xH30, 90x73xH45, 90x73xH60 cm

Weight 24 Kg



SOFT PLYO BOX 3 IN 1

cod. AHF-164

I - Piattaforma 3 in 1 ad altezza regolabile per esercizi pliometrici. Robusta struttura in legno, imbottitura in polietilene espanso (EVA) da 2 cm, rivestimento in PVC. Bordi stondati, per limitare le conseguenze degli urti. Dotato di cerniera.

Dimensioni: 76x61xH51 cm.

Peso 23 Kg

EN - Adjustable 3-in-1 platform for plyometric exercises. Made of sturdy wood panels with EVA filling and PVC cover with zip. Rounded edges, to decrease impact consequences.

Dimensions 76x61xH51 cm.

Weight 23 Kg



SOFT PLYO BOX LIGHT 3 IN 1

cod. AHF-199

I - Piattaforma 3 in 1 ad altezza regolabile per esercizi pliometrici. Struttura in FOAM e polistirolo ad alta densità, rivestimento in PVC dotato di cerniera. Bordi stondati, per limitare le conseguenze degli urti.

Dimensioni: 76x61xH51 cm.

Peso 15 Kg

EN - Adjustable 3-in-1 platform for plyometric exercises. Made of high density FOAM and polystyrene filling and PVC cover with zip. Rounded edges, to decrease impact consequences.

Product dimensions 76x61xH51 cm.

Weight 15 Kg



PLYO BOX 3 IN 1 CON FINITURA ANTISCIVOLO**PLYO BOX 3 IN 1 WITH ANTISLIP FINISHING****cod. AHF-255**

I - Piattaforma 3 in 1 ad altezza regolabile per esercizi pliometrici . Consente l'utilizzo su tre diverse altezze 51 / 61 / 76 cm. Realizzato in robusti pannelli in legno lavorati con macchinari CNC e bisellati. Finitura honeycomb antiscivolo. Fissaggio ad incastro ed ampio rinforzo interno a croce per resistere a tutte le sollecitazioni. Utilizzabile anche come piano di appoggio o basamento per esercizi con bilanciere. Fori per la presa su 2 lati. Kit di montaggio e istruzioni incluse. Dimensioni 76x61xH51 cm. Peso 20 Kg

EN - Adjustable 3-in-1 platform for plyometric exercises. Allows use on three different heights 51/61/76 cm. Made of sturdy wood panels CNC machined and beveled . Antislip honeycomb finishing. Non Interlocking fixing and strong inner cross reinforcement to endure all stresses. Can also be used as a support platform or base for exercises with barbells. Hole for grip on the 2 opposite sides. Mounting kit and instructions included. Dimensions 76x61xH51 cm. Weight 20 Kg

**PLYO BOX 3 IN 1****cod. AHF-140**

I - Piattaforma 3 in 1 ad altezza regolabile per esercizi pliometrici. Consente l'utilizzo su tre diverse altezze 51 / 61 / 76 cm. Realizzato in robusti pannelli in legno lavorati con macchinari CNC e bisellati. Fissaggio ad incastro ed ampio rinforzo interno a croce per resistere a tutte le sollecitazioni. Fori per la presa su 2 lati. Kit di montaggio e istruzioni incluse. Dimensioni 76x61xH51 cm. Peso 20 Kg

EN - Adjustable 3-in-1 platform for plyometric exercises. Allows use on three different heights 51/61/76 cm. Made of sturdy wood panels CNC machined and beveled. Interlocking fixing and strong inner cross reinforcement to endure all stresses. Can also be used as a support platform or base for exercises with barbells. Hole for grip on the 2 opposite sides. Mounting kit and instructions included. Dimensions 76x61xH51 cm. Weight 20 Kg



SLITTA CROSSTRaining

CROSSTRaining SLED

cod. AHF-187

I - Dotata di due binari di acciaio da 10 cm e barre di spinta verticale con bloccaggio a vite. Piano di carico con un'asta di appoggio per i pesi alta 64 cm. Il suo diametro di 50 mm consente l'utilizzo di dischi peso olimpici. Adatto al montaggio di imbracature o cinghie.

Dimensioni slitta: 108,6 x 105 x H60 cm

Dimensioni attacchi pesi: 64 x 5 cm (AxØ).

Dimensione barre di spinta: 96 x 5 cm (AxØ).

Peso: 33 kg. Peso max caricabile 150 kg.

EN - Equipped with 2 steel rails 10 cm wide and pushing bars fixed with screws. Large loading surface with central column 64 cm tall suitable for olympic weight plates with \varnothing 50 mm hole. Suitable for harness or power rope fixing.

Sled dimensions: 108,6 x 105 x H60 cm

Weight plates holder dimensions: 64 x 5 cm (HxØ).

Pushing bars dimensions: 96 x 5 cm (HxØ).

Weight: 33 kg. Max load weight 150 kg



PETTORINA PER SLITTA CROSSTRaining

CROSSTRaining SLED HARNESS

cod. AHF-279

I - Sistema di cinghie in cordura di nylon per imbracatura per slitta crosstraining. Regolabile. Taglia unica.

EN - Cordura nylon strap system for the crosstraining sled harness. Adjustable. One size.



CROSS MAT

cod. AHF-095

I - Cuscino lombare sagomato, si adatta perfettamente alle curve della schiena, fornendo un supporto ideale durante l'allenamento grazie all'estruso in foam ad alta intensità. Ottimo per un allenamento concentrato su addominali e muscoli del core.

EN - The contoured design perfectly fits the back curves, providing the best support during the workout thanks to the high density foam cushion. Ideal for abdominal exercises and core training



HEAD MAT

cod. AHF-184

I - Innovativo cuscino disegnato per il massimo comfort durante le flessioni verticali. La sagoma arcuata su entrambi i lati del cuscino, si adatta perfettamente al posizionamento dei dischi bumper. Imbottitura in schiuma poliuretana (EPE) a densità differenziata con rivestimento in PVC.

Dimensioni: 47x50xH5 cm

EN - Innovative pad specifically designed for an ideal comfort during handstand push-ups. Includes arched cut-outs on each side of the pad, ideally suited for the placement of bumper plates. EPE (polyurethane foam) filling with PVC cover.

Dimonsions: 47x50xH5 cm



TIMER

cod. AHF-154

I - Dispositivo per la scansione dei tempi di allenamento. Dimensioni 64x16xH5 cm. LED a 6 cifre, programmi preimpostati, telecomando wireless, cassa in alluminio, alimentazione di rete 12V. Funzioni: tempo 24h, intervallo di tempo, conteggio, 2 conteggi personalizzati. Programmi preimpostati: FIGHT 5' round + 1' riposo, TABATA 8x20" round + 10" riposo, timer stopwatcher, 10" count down prima di ogni funzione, reset.

EN - Device for training time scanning. Dimensions 64x16xH5 cm. LED 6 digits, pre set programs, wireless remote control, aluminium case, 12V. Functions: time 24h, interval timer, count down, 2 custom count up. Pre set programs: FIGHT 5' rounds + 1' rest, TABATA 8x20" rounds + 10" rest, stopwatcher timer, 10" count down before each function, reset.



CORDA DA SALTO VELOCE PROFESSIONALE IN ACCIAIO CON MANOPOLE IN ALLUMINIO

PROFESSIONAL STEEL SPEED ROPE WITH ALUMINUM HANDLES

cod. AHF-258

I - Manopole ergonomiche antiscivolo in alluminio. Impugnatura girevole su cuscinetti a sfera. Cavo in acciaio plastificato, per una rotazione fluida e veloce. Adatta anche per allenamenti di Kombat. Lunghezza corda regolabile

EN - Aluminum ergonomic handle with non-slip grip. Turning handle on ball bearings. Steel cord for a quick and smooth rotation. Also suitable for Kombat training. Adjustable rope length



SAFETY MAT

cod. AHF-188

I - Ampio materasso antiurto, imbottitura in spugna e polietilene espanso. Adatto al sistema modulare di gabbie TOORX (Challenge e Master). Dotato di comode maniglie per una movimentazione più facile e confortevole. Rivestimento in PVC. Dimensioni: 105x168xH40 cm

EN - Large shockproof mat, made of sponge and expanded polyethylene. Suitable for TOORX crosstraining rigs (CHALLENGE and MASTER). Handles for easy transportation. PVC cover. Product dimensions: 105x168xH40 cm





04

ACCESSORI - ACCESSORIES 2024

ATHLETICS

**OSTACOLO DA ALLENAMENTO
CON ALTEZZA REGOLABILE
HURDLE SET WITH ADJUSTABLE HEIGHT**

cod. AHF-265

I - Set 5 ostacoli in tubo tondo d'acciaio regolabili in altezza su 4 posizioni e autoportanti.
Dimensione ostacolo: 46x32x22/32 cm

EN - Set of 5 obstacles made of round steel tube, adjustable on 4 different heights self-standing.

Obstacle size: 46x32x22/32 cm



**SET CONI E PALI AGILITY
AGILITY CONES & POLES SET**

cod. AHF-171

I - Set 10 coni agility a 12 fori con borsa di trasporto. Cono a 12 fori - altezza cm 32 per posizionamento palo su 4 differenti altezze: 9,5/17/24,5/32 cm. Scanalatura sulla sommità e foro per posizionamento palo in verticale.

EN - 10 agility cones set with 12 holes and carry bag. Cone with 12 holes - height cm 32 for pole position on 4 different heights: 9,5/17/24,5/32 cm. Top grooving and hole for vertical pole position.

cod. AHF-172

I - Set 10 pali agility con borsa di trasporto. Palo in PVC cm 170 x ø 25 mm. Ideali per allenamento funzionale e agility

EN - 10 agility poles set with carry bag. PVC pole cm 170 x ø 25 mm. Ideal for functional and agility workout

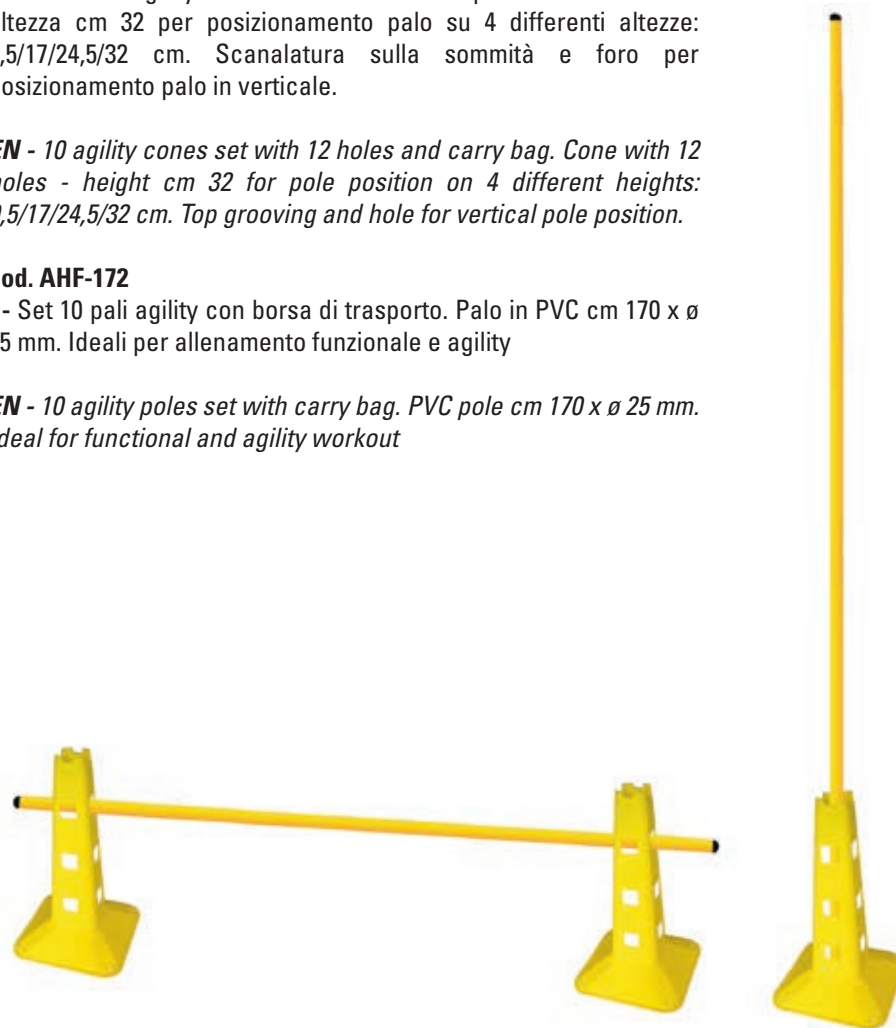

**CORDA DA SALTO VELOCE IN ACCIAIO
CON MANOPOLE IN PLASTICA**
STEEL SPEED JUMP ROPE WITH PLASTIC HANDLES

I - Manopole ergonomiche in plastica. Impugnatura girevole su cuscinetti a sfera. Cavo in acciaio plastificato, per una rotazione fluida e veloce. Adatta anche per allenamenti di boxe e mma. Lunghezza corda regolabile.

EN - Plastic ergonomic handle. Turning handle on ball bearings. Steel cord for a quick and smooth rotation. Also suitable for boxing and mma training. Adjustable rope length.

- cod. AHF-086 - nero-black
- cod. AHF-102 - rosso-red
- cod. AHF-103 - azzurro-light blue
- cod. AHF-104 - fucsia-fuchsia



CONI AGILITY QUADRA
QUADRA AGILITY CONES

cod. AHF-278

I - Set da 10 pz - 2 differenti colori. Leggero, pratico, impilabile, in materiale polimerico antiurto, ad alta visibilità. Dimensione cono tronco piramidale 18x18xH5 cm

EN - 10 pcs set - 2 different colours. Lightweight, practical, stackable, made of shockproof polymer material, high visibility. Truncated pyramid cone dimensions 18x18xH5 cm



CONI AGILITY
AGILITY CONES

cod. AHF-135

I - Set da 24 pz - 4 differenti colori. Dimensione cono ø19xH5 cm. Comodi da riporre grazie allo stand in ABS incluso. Ideali per allenamento funzionale e agility.

EN - 24 pcs set - 4 different colours. Cone dimensions ø19xH5 cm. Easy to storage with the ABS stand included. Ideal for functional and agility workout



SCALETTA A ROTOLO **ROLL LADDER**

cod. AHF-277

I - Alternativa alla più classica scala distesa, la scaletta in gomma a rotolo rimane più facilmente in posizione. Lavabile, arrotolabile e facile da trasportare
10 posizioni

EN - Alternative to the more classic flat ladder, the rubber roll ladder remains in position more easily. Washable, rollable and easy to carry. 10 positions

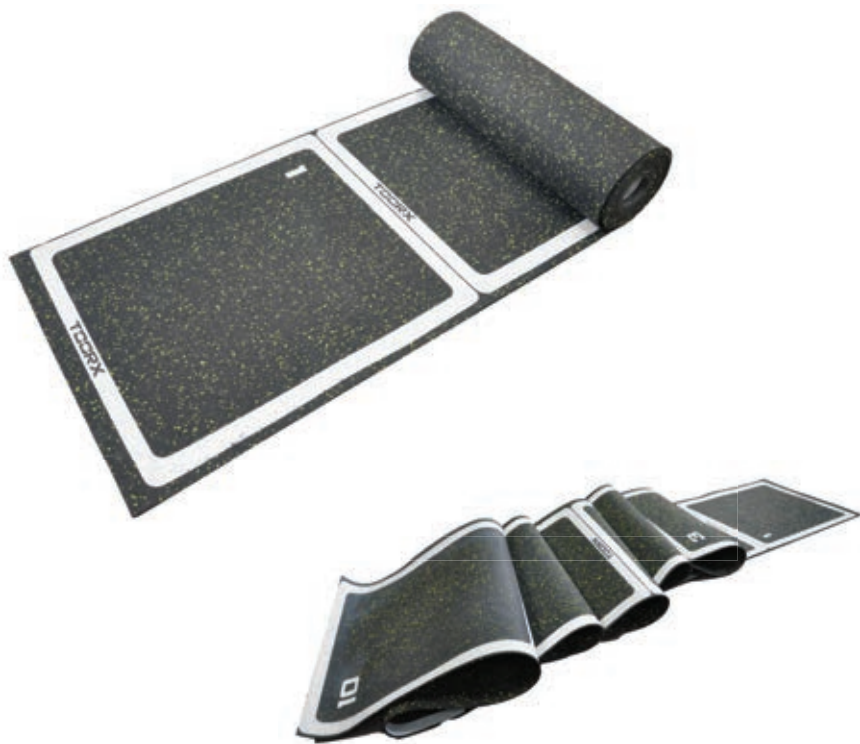

SCALETTA VELOCE **SPEED LADDER**

cod. AHF-134

I - Lunghezza 4,5 mt. N° 9 pioli a distanza regolabile. Borsa di trasporto con inserto in rete inclusa. Ideale per migliorare l'accelerazione, la velocità e il rapido cambio di direzione.

EN - Length 4,5 mt. N° 9 rungs - adjustable distance. Carry bag with mesh insert included. Improves acceleration, speed and change of direction.

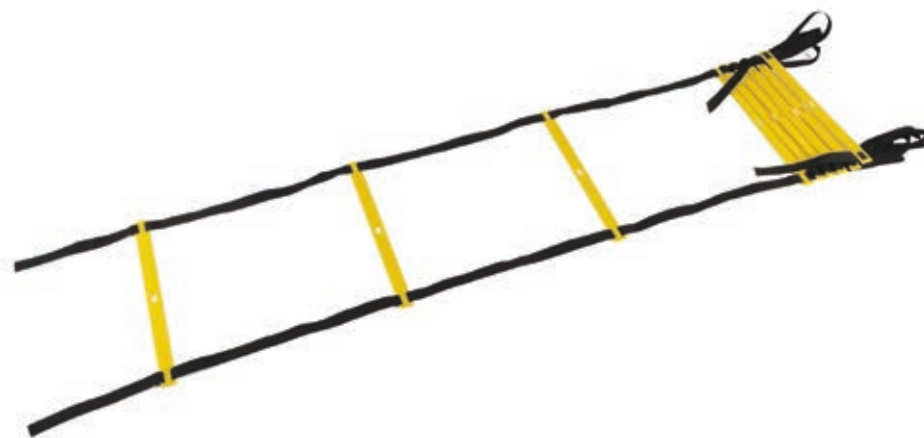

SCALETTA RICHIUDIBILE HEX FOLDING HEX LADDER

cod. AHF-276

I - Evoluzione della scala classica, questa composizione di esagoni, facile da stendere e da richiudere, permette molteplici variazioni nella geometria degli appoggi negli esercizi di agility.

EN - Evolution of the classic ladder, this composition of hexagons, easy to extend and fold, allows multiple variations in the geometry of the supports in agility exercises.



AGILITY DOTS

cod. AHF-264

I - Set 10 pz. dots, consentono di delimitare le diverse zone di allenamento e identificare i punti di cambio di direzione/passaggio negli esercizi di agility.

EN - Set 10 pcs. dots for marking different training zones and identifying the pace change points in agility exercises.



PARACADUTE FRENANTE BRAKING PARACHUTE

cod. AHF-259

I - Ideale per sviluppare velocità, accelerazione, resistenza e esplosività. Rafforza e potenzia i muscoli e migliora la tecnica di corsa. Paracadute in poliestere ø 137 cm con inserti in rete per una maggiore stabilità.

Da 8 a 20 kg di resistenza a seconda della velocità di corsa

EN - Ideal to develop speed, acceleration, resistance and explosiveness. Strengthens and reinforces the muscles and improves the running technique. Polyester parachute ø 137 cm with net inserts for an increased stability.

From 8 to 20 kg resistance, depending on the running speed

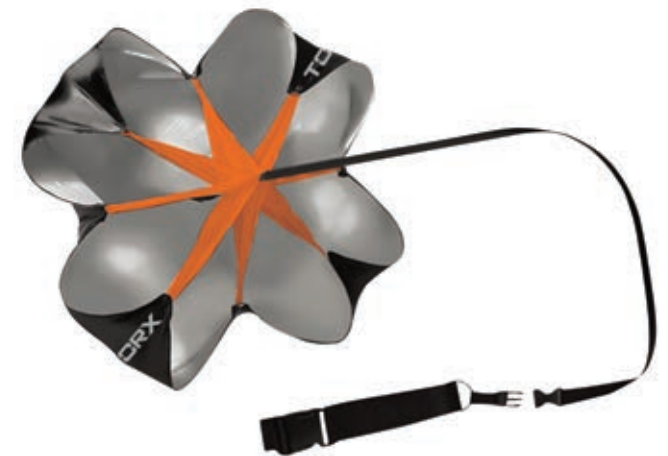

SLITTA AGILITY AGILITY TRAINING SLED

cod. AHF-186

I - Slitta per potenziamento adatta all'allenamento in palestra o all'aperto. Dotata di due binari di acciaio e occhielli in acciaio con 10 mm di diametro per fissare eventuali imbracature. 2 cinghie incluse. Porta dischi peso con foro \varnothing 25 mm. Adattatore per dischi peso con foro \varnothing 50 mm incluso. Dimensioni: 97x 28 x H60 cm

EN - Sled suitable for strengthening training in gyms or outdoors. Equipped with 2 steel rails and \varnothing 10 mm steel eyelets for harness and power rope fixing. 2 Harness included. Plates holder suitable for weight plates with \varnothing 25 mm hole. Adapter for weight plates with \varnothing 50 mm hole included. Dimensions: 97x 28 x H60 cm



ELASTICO ACCELERATORE SPEED RESISTOR

I - Elastico acceleratore rivestito con guaina in nylon, studiato per aumentare la resistenza e la forza esplosiva pliometrica. Moschettoni in acciaio. Disponibile nelle intensità light e strong. Lunghezza 3.5 mt

EN - Resistance elastic tube with nylon covering, studied for forcing the athlete to a constrained run and limited range of action. Steel snap-hook. Available with light and strong resistance. Length 3.5 mt

cod. AHF-150 - light (nero/grigio - black/gray)

cod. AHF-151 - strong (nero/rosso - black/red)



SET PER ELASTICO ACCELERATORE SPEED RESISTOR ACCESORIES SET

cod. AHF-152

I - Set composto da: 1 cintura d'imbraco - misura unica - 1 laccetto per fissaggio

EN - Set made up of: 1 belt - one size fits all - 1 fixing strap



TUBO ELASTICO CON GUAINA E MANIGLIE IN GOMMA ABSOLUTE

ELASTIC TUBE WITH RUBBER HANDLES ABSOLUTE

I - Elastico tubolare con 3 differenti intensità, riconoscibili per colore. Impugnatura in gomma. Tonifica e sviluppa i muscoli di braccia, gambe, addome, spalle e petto.

EN - Elastic tubes with 3 different resistances and colours. Rubber handles. Tones and strengthens arms, legs, gluteus, abdominals, shoulders and chest muscles.

cod. AHF-167 - 5x8x1200 mm - light giallo/yellow

cod. AHF-168 - 6x10x1200 mm - medium azzurro/light blue

cod. AHF-169 - 6x12x1200 mm - strong rosso borgogna/burgundy



POWER BAND

I - Elastico di resistenza ad anello, in gomma, ideale per il potenziamento e per agevolare gli esercizi di pull up e muscle up. Il massimo valore della trazione viene calcolato al doppio della sua lunghezza, rispetto alla posizione di riposo. Ogni colore corrisponde ad una diversa resistenza.

EN -Loop resistance elastic band. Rubber made, ideal for strengthening and to facilitate pull up and muscle up exercises. The maximum traction value is calculated at double its length, compared to the rest position. Each color corresponds to a different resistance.

cod. AHF-251 - 2080 x 4,5 x 6,5 mm - arancione-orange

cod. AHF-128 - 2080 x 4,5 x 13 mm - rosso-red

cod. AHF-129 - 2080 x 4,5 x 22 mm - nero-black

cod. AHF-130 - 2080 x 4,5 x 29 mm - viola-purple

cod. AHF-131 - 2080 x 4,5 x 45 mm - verde-green

cod. AHF-132 - 2080 x 4,5 x 64 mm - blu-blue



CONFEZIONE 10 ELASTICI IN LATTICE AD ANELLO Ø 30 CM

Ø 30 CM LOOP LATEX BANDS - 10 PCS PACKAGE

I - Nata come gluteus band, questa fascia anulare in lattice è utile per numerosi esercizi di condizionamento muscolare, basati su resistenza elastica. Ogni colore corrisponde ad una diversa resistenza.

EN - Born as a gluteus band, this annular latex band is useful for numerous muscle conditioning exercises, based on elastic resistance. Each color corresponds to a different resistance.

cod. AHF-183 - light giallo/yellow

cod. AHF-200 - medium verde/green

cod. AHF-201 - strong rosso/red



BANDA ELASTICA IN TESSUTO CON ASOLE
TEXTILE STRETCH STRAP WITH LOOPS

I - Estremamente versatile e adatta per rieducazione, stretching ed esercizi di tonificazione. Dotata di 8 asole da 15 cm, più asola centrale da 25 cm. I riferimenti numerici su ciascuna asola corrispondono ai differenti livelli di intensità di sforzo, crescenti in base al grado di allenamento. Disponibile in due differenti intensità: light (resistenza 10 kg) e strong (resistenza 15 kg). Lunghezza 145 cm.

EN - Extremely versatile and suitable for physical therapy, stretching and toning exercises. Length 145 cm. 8 loop handles 15 cm + 1 central loop handle 25 cm size. The numerical references on each loop correspond to the different resistance levels, increasing according to the training program. Available with two different resistances: light (10 kg) and strong (15 kg).

cod. AHF-142 - light grigio/gray
cod. AHF-143 - strong rosso/red



CONFEZIONE 5 ELASTICI AD ANELLO IN TESSUTO
TEXTILE LOOP BANDS - 5 PCS PACKAGE

I - Nata come gluteus band, questa fascia anulare in tessuto elastico è utile per numerosi esercizi di condizionamento muscolare, basati su resistenza elastica. Disponibile in tre differenti intensità. Set da 5pz.

EN - Born as a gluteus band, this annular latex band is useful for numerous muscle conditioning exercises, based on elastic resistance. Available with 3 different resistances. 5 pcs. Set.

cod. AHF-266 - light 5x75 cm
cod. AHF-267 - medium 6x75 cm
cod. AHF-268 - strong 7,5x75 cm



COPPIA POLSIERE/CAVIGLIERE APPESANTITE CON PESI ESTRAIBILI WRIST/ANKLE WEIGHTS WITH REMOVABLE WEIGHT BAGS

cod. AHF-093 - 2x2,5 Kg

I - Ideali durante allenamenti di ginnastica, fitness e potenziamento muscolare. Sistema di chiusura regolabile con velcro. Adatto a polsi e caviglie. Sacche peso estraibili con doppio rivestimento e chiusura di sicurezza con velcro. Aumenta l'intensità dell'allenamento

EN - Ideal during gym, fitness and muscle strengthening workout. Adjustable lock system with velcro. Suitable both for wrist and ankle. Removable weight bags with double cover and safe lock with velcro. Increases intensity during exercise



COPPIA POLSIERE/CAVIGLIERE APPESANTITE WRIST/ANKLE WEIGHTS

I - Ideali durante allenamenti di ginnastica, fitness e potenziamento muscolare. Sistema di chiusura regolabile con velcro. Adatto a polsi e caviglie

EN - Ideal during gym, fitness and muscle strengthening workout. Adjustable lock system with velcro. Suitable both for wrist and ankle

cod. AHF-071 - 2x0,5 Kg verde lime/lime green

cod. AHF-072 - 2x1 Kg arancio/orange

cod. AHF-073 - 2x1,5 Kg nero/black

cod. AHF-094 - 2x2 Kg rosso/red





TOORX

6' 24"



TOORX

TE
ROFE

05

ACCESSORI - ACCESSORIES 2024

STUDIO

SET PUMP LIGHT

cod. BPS- LN

I - Set pump 10 Kg. Contiene: 2 coppie di dischi gommati - 2 x 2,5 Kg + 2 x 1.25 Kg + 1 bilanciere rivestito in foam antiscivolo + 2 ferma dischi a molla.

EN - Set pump 10 Kg. Contains: 2 x 2.5 Kg + 2 x 1.25 Kg rubber weight plates + 1 hollow bar foam coated + 2 spring clipsafety collars.



cod. BP-CFF



SET PUMP 20 Kg

cod. BPSN

I - Set pump 20 Kg. Contiene: 3 coppie di dischi gommati - 2 x 5 Kg, 2 x 2.5 Kg, 2 x 1.25 Kg + 1 bilanciere rivestito in foam antiscivolo + 2 ferma dischi a molla

EN - Set pump 20 Kg. Contains: 2 x 5 Kg, 2 x 2.5 Kg, 2 x 1.25 Kg rubber weight plates + 1 hollow bar foam coated + 2 spring clip safety collars



cod. BP-CFSL



ACCESSORI - ACCESSORIES

cod. BP-B

I - Bilanciere rivestito in foam antiscivolo per set pump - ø 30 mm.

EN - Hollow bar foam coated for set pump - ø 30 mm.

cod. BP-CFF

I - 2 ferma dischi a molla per set pump.

EN - 2 spring clip safety collars for set pump.

cod. BP-CFSL

I - 2 ferma dischi safe lock per set pump.

EN - 2 collars safe lock for set pump.

cod. BP-4x1,25N

I - Set 4 dischi peso kg. 1,25 colore grigio per set pump

EN - 4 weight plates 1.25 kg for set pump – gray colour

cod. BP-4x2,5N

I - Set 4 dischi peso kg. 2,5 colore arancio per set pump

EN - 4 weight plates 2.5 kg for set pump – orange colour

cod. BP-4x5N

I - Set 4 dischi peso kg. 5 colore nero per set pump.

EN - 4 weight plates 5 kg for set pump – black colour

RASTRELLIERA PORTA SET PUMP 20 POSTI **SET PUMP RACK 20 PLACES**

cod. RBP-B20

I - Rastrelliera porta set pump set (20 posti). Dotato di perni porta dischi, rack porta bilancieri e ripiano per riporre i ferma dischi. Dotato di pratiche maniglie e ruote piroettanti con fermo di sicurezza. Dimensione prodotto: 100x80xH138 cm.

EN - Set pump rack (20 places). Equipped with weight plates holders and shelf for safety collars storage. Lockable castor wheels and handles for safe and easy transport. Product size: 100x80xH138 cm.



RASTRELLIERA PORTA SET PUMP 12 POSTI **SET PUMP RACK 12 PLACES**

cod. RBP-B12

I - Rastrelliera compatta salvaspazio porta set pump (12 posti). Dotato di perni porta dischi, rack porta bilancieri e perni porta ferma dischi. Dimensione prodotto: 75x66xH157 cm.

EN - Compact space saving set pump rack (12 places). Equipped with weight plates holders, barbells rack and safety collars holders. Product size: 75x66xH157 cm.



BODY BARS

I - Tubo zavorrato per esercizio di potenziamento a bassa intensità. Le teste dei tubi, a seconda del colore, discriminano i diversi tagli peso.

EN - Weighted tube for low intensity strengthening exercise. The tube heads colour depends on the size

cod. BB-2 - Kg. 2

cod. BB-3 - Kg. 3

cod. BB-4 - Kg. 4

cod. BB-5 - Kg. 5

cod. BB-6 - Kg. 6



RASTRELLIERA PORTA BODY BAR BODY BARS RACK

cod. RBB-B

I - Rastrelliera porta body bar (5 scomparti), adatto a contenere 20 body bar.
Dimensioni : 37x31xH120 cm

*EN - Body bars rack (5 compartments), suitable for stocking 20 body bars
Dimensions : 37x31xH120 cm*



TRAMPOLINO PRO

TRAMPOLINE PRO

cod. TF-03

I - Trampolino professionale richiudibile. Telaio in tubolare a sezione quadrata 25x25 mm. 8 gambe ripieghevoli con gommini anti scivolo. Telo di rimbalzo in materiale ultra-resistente, con doppie cuciture di rinforzo. 40 molle oversize con connettori a "V" e guarnizioni di sicurezza anti-espulsione. Fornito con ricambi inclusi: 1 telo + 1 molla + 1 piede di appoggio. Diametro 122 cm. Dimensione chiuso: 122x68xH9 cm

EN - Professional trampoline. Foldable structure Squared heavy-duty steel tubing 25x25 mm. 8 foldable legs with no slip rubber feet. Ultra strong jumping mat with double stitching. 40 oversize springs with "V" conjunctions and special safety rubbers anti injection. Spare parts included: 1 jumping mat + 1 spring + 1 leg. Diameter 122 cm. Folded dimensions: 122x68xH9 cm



STEP PRO

cod. AHF-003

I - Superficie antiscivolo. Regolabile in altezza su 3 livelli. Dimensioni 99x38xH15/20/25 cm.

EN - Non-slip surface. 3-level adjustable height. Dimensions 99x38xH15/20/25 cm.



SACCO FIT BOXE EVO CON BASE ABSOLUTE
FIT BOXING BAG EVO WITH BASE ABSOLUTE



cod. BOT-044

I - Colpitore: ecopelle nero effetto carbonio. Schiuma ad alta densità. Sacco regolabile su 3 altezze. Base zavorrabile con acqua o sabbia.

Dimensioni ø35xH100 cm.

EN - Eco-leather material black with carbon effect. Bag adjustable height on 3 levels. Base easily filled with water or sand.

Dimensions ø35xH100 cm



SACCO FIT BOXE CON BASE
FIT BOXING BAG WITH BASE



cod. BOT-043

I - Colpitore: ecopelle rosso. Schiuma ad alta densità. Sacco regolabile su 3 altezze. Base zavorrabile con acqua o sabbia.

Dimensioni ø35xH100 cm.

EN - Eco-leather material black with carbon effect. Bag adjustable height on 3 levels. Base easily filled with water or sand.

Dimensions ø35xH100 cm



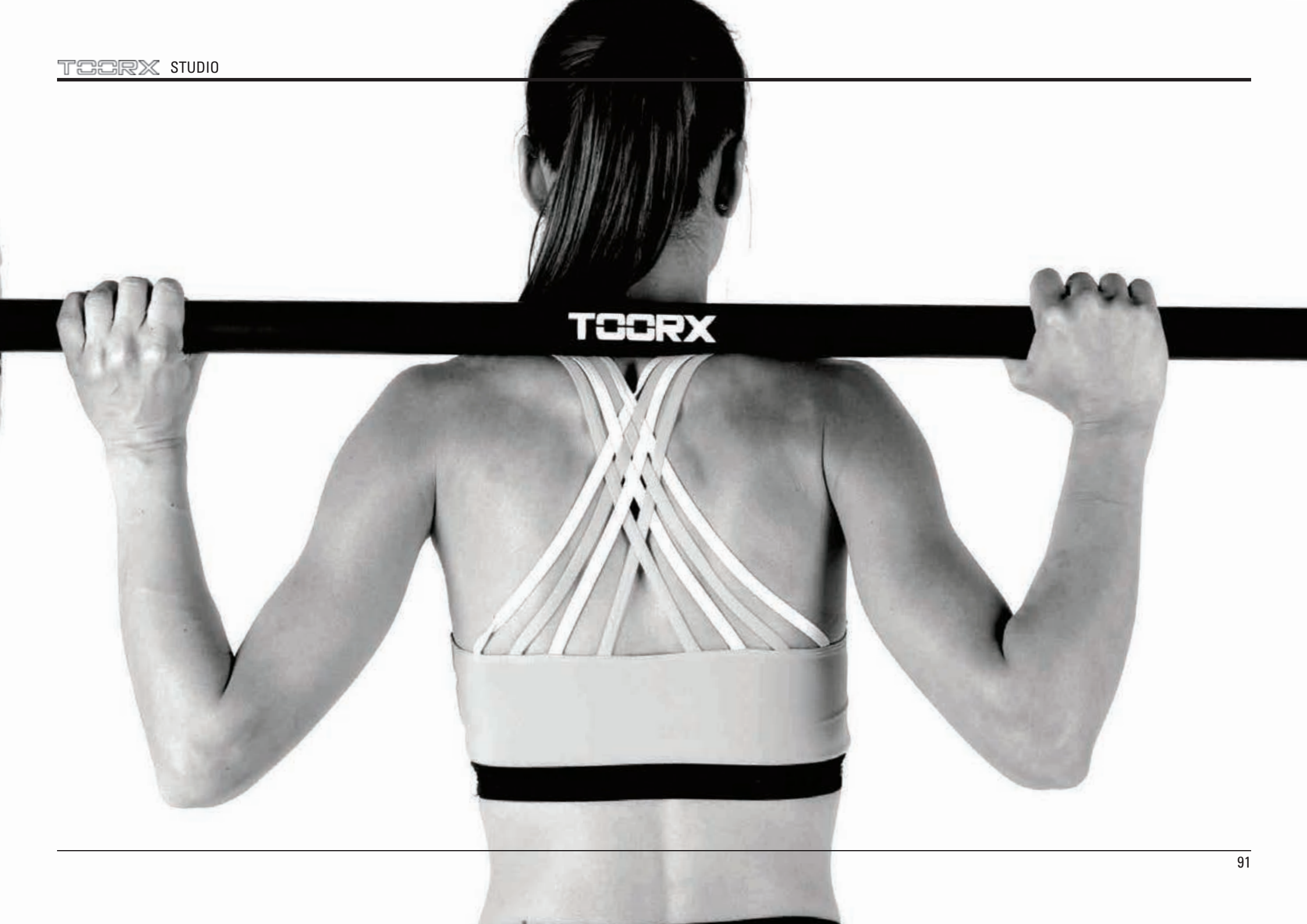

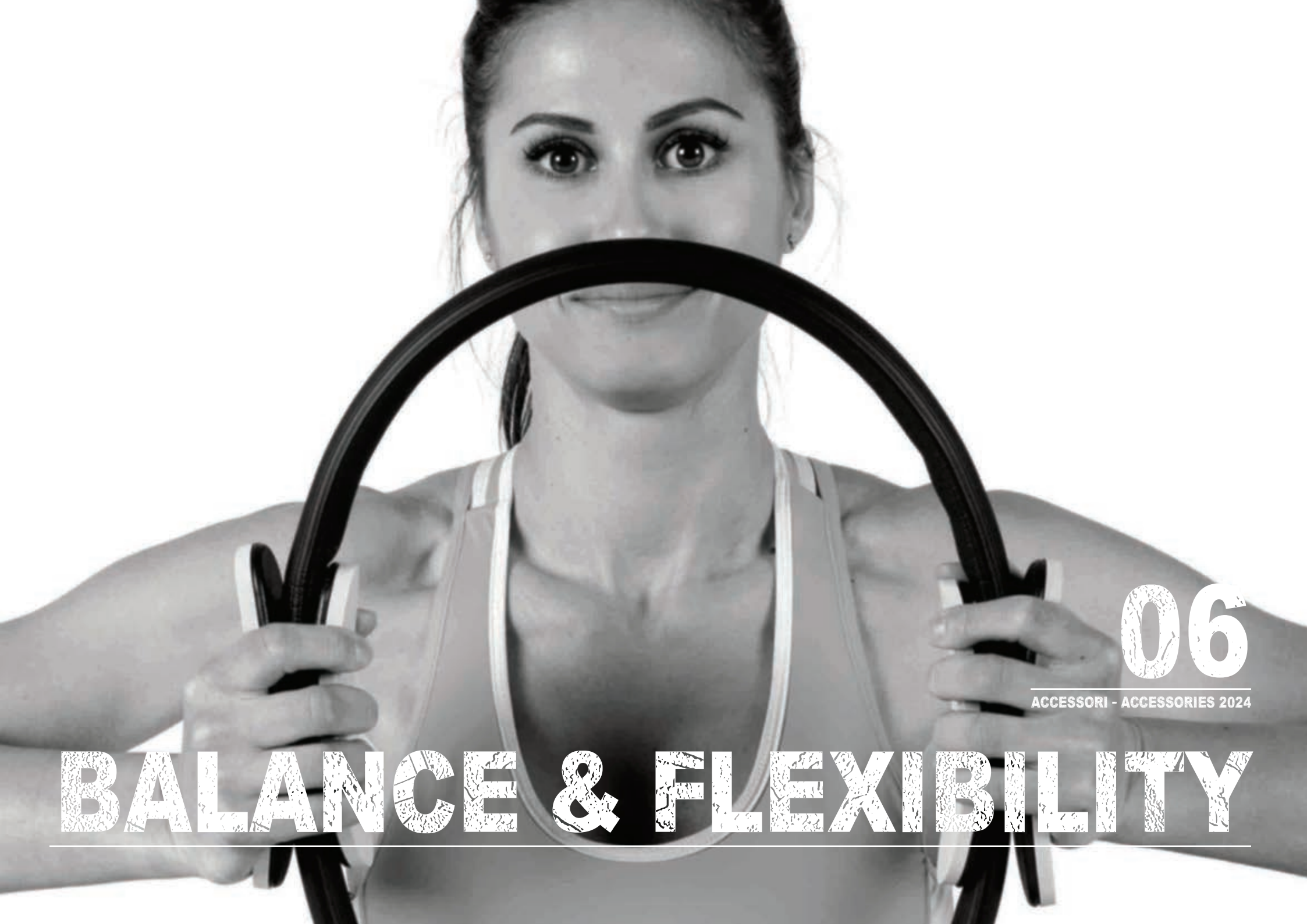

06

ACCESSORI - ACCESSORIES 2024

BALANCE & FLEXIBILITY

PALLA BOSU EVO ABSOLUTE
BOSU GYM BALL EVO ABSOLUTE

cod. AHF-170

I - Diametro 63 cm, altezza 22 cm. Attrezzo multiuso, ideale per il fitness, esercizi di yoga, pilates e propriocezione grazie ai diversi gradi di instabilità controllata. Utilizzabile su due lati. Migliora la stabilità e l'equilibrio per un allineamento ottimale. Con ganci per utilizzo tiranti elastici.

EN - Diameter 63 cm, height 22 cm. Multi functional devise, suitable for fitness, yoga, pilates workouts and balance training. Thanks to different levels of regulated instability. Usable dome or platform side down. Provides stability and balance to help with optimal alignment. With hooks for elastic tubes.



PALLA DA GINNASTICA PRO
GYM BALLS PRO

I - Adatto ad un uso intensivo. Antiscoppio. Migliora l'equilibrio. Rafforza i muscoli di schiena e addome. Carico massimo 500 Kg.

EN - Heavy duty. Antiburst. Provides balance. Strenghtens back and abdominal muscles. Max load 500 kg.

cod. AHF-147 - ø55 cm blu/blue

cod. AHF-148 - ø65 cm grigio/gray

cod. AHF-149 - ø75 cm grigio antracite/charcoal gray



BALANCE BOARD IN LEGNO
WOODEN BALANCE BOARD

cod. AHF-136

I - Diametro 40 cm, spessore tavola 1,75 cm. Superficie gommata antiscivolo. Migliora la stabilità e l'equilibrio per un allenamento ottimale. Ideale per esercizi di rafforzamento muscolare e riabilitativi, in ambiente di parziale instabilità.

EN - ø 40 cm, board thickness 1,75 cm. Non-slip rubber surface. Provides stability and balance to help with optimal alignment. Gives the muscular system new stimulation and strength, thanks to its partial instability.



BALANCE MAT

cod. AHF-272

I - Supporto per l'allenamento in ambiente instabile, questo materassino in polimero a deformazione controllata permette esercizi di potenziamento e rieducazione motoria post traumatica. Grazie al rateo costante di deformazione, permette una verifica dei progressi ed una somministrazione razionale del lavoro.

EN - Support for training in an unstable condition, this controlled deformation polymer mat allows strengthening exercises and post-traumatic motor re-education. Thanks to the constant rate of deformation, it allows a check of progress and a rational administration of the work.



PILATES RING

I - Diametro 38 cm. Tonifica braccia, schiena, petto, interno ed esterno cosce e polpacci. Manici anatomici. Disponibile in due differenti intensità: light e strong.

EN - Diameter 38 cm. Tones arms, chest, shoulders, legs and calves. Anatomical handle.

Available with two different resistances: light and strong.

cod. AHF-067 - light nero-lime/black-lime

cod. AHF-275 - strong nero-viola/black-purple



MATTONE YOGA YOGA BRICK

cod. AHF-025

I - Supporto ideale per esercizi di pilates, yoga e stretching. Fornisce stabilità ed equilibrio per un allineamento ottimale della catena cinetica.

EN - Ideal for pilates, yoga and stretching exercises. Provides stability and balance to help with optimal alignment.



PALLA PER YOGA YOGA BALL

cod. AHF-045

I - Diametro 25 cm. Ideale per rafforzare e rilassare la muscolatura. Adatta anche per esercizi di rieducazione muscolare.

EN - Diameter 25 cm. Reduces muscle tension and increases muscular endurance. Also suitable for rehabilitative exercises.



ASTE IN LEGNO PER CORPO LIBERO WOODEN STICKS

cod. AHF-271

I - Set 10 pz. ø 25 mm x H160 cm. In legno naturale, finitura atossica.

EN - Set of 10 pcs ø 25 mm x H160 cm. Natural wood non-toxic finishing.

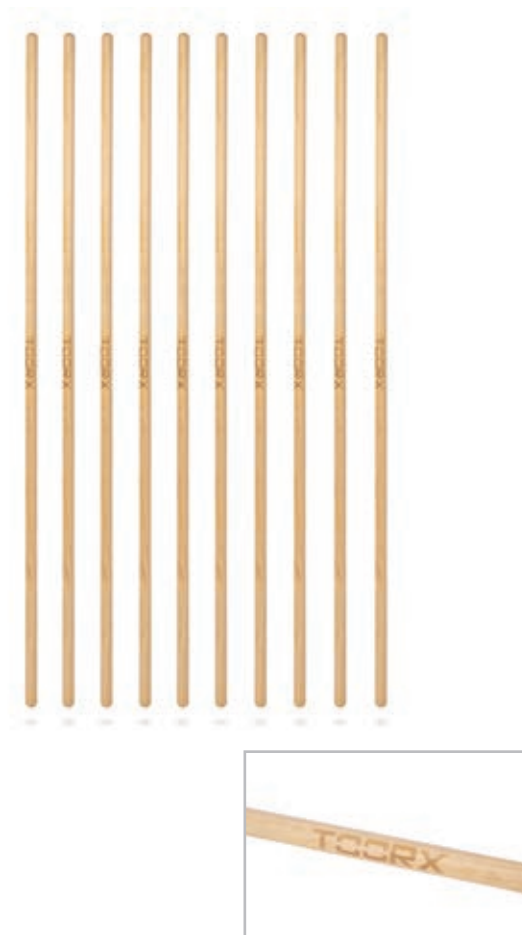

RULLO MASSAGGIO ED ALLENAMENTO YOGA GRID FOAM YOGA ROLLER

I - Ideale per stimolazioni mirate, massaggio connettivale e rilassamento muscolare. Favorisce il recupero post sforzo, ripristinando la normale capacità contrattile del fuso muscolare. Dimensioni 33 x ø 14 cm.

EN - Ideal for targeted stimulation, connective tissue massage and muscle relaxation. It promotes post-exertion recovery, restoring the normal contractile capacity of the muscle spindle. Dimensions 33 x ø 14 cm.

cod. AHF-044 - nero/black

cod. AHF-061 - arancio/orange



PILATES ROLLER

I - Pilates roller in EVA. Costruito mediante estrusione da stampo, diverso rateo di compressione tra nucleo più rigido e copertura esterna più morbida.

EN - Pilates eva roller built by mold extrusion, different compression rate between stiffer core and softer outer cover.

cod. AHF-269 - $\phi 15$ cm x 45 cm



cod. AHF-270 - $\phi 15$ cm x 90 cm

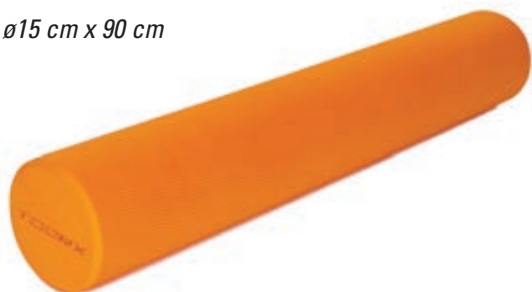

cod. AHF-273 - $\phi 15$ cm x 90 cm
Semi roller



MATERASSINO FITNESS STUDIO CON OCCHIELLI FITNESS STUDIO MAT WITH EYELETS

I - Morbida e confortevole superficie in vinile. Dotato di occhielli per riporlo più comodamente in palestra. Facilmente igienizzabile, impermeabile alla traspirazione.

EN - Soft and comfortable vinyl non-slip surface. Chromed eyelet for hang up storage in gyms. Easy to sanitize, perspiration-proof.

cod. MAT-100STUDIO - 100x60x1 cm

cod. MAT-120STUDIO - 120x60x1 cm

cod. MAT-173STUDIO - 173x60x1 cm



MATERASSINO FITNESS CON OCCHIELLI **FITNESS MAT WITH EYELETS**

I - Morbida e confortevole superficie antiscivolo. Dotato di occhielli per riporlo più comodamente in palestra. Facile da pulire ed impermeabile alla traspirazione. Dimensioni 100x61x1,5 cm.

EN - Soft and comfortable vinyl non-slip surface. Chromed eyelet for hang up storage in gyms. Easy to sanitize, perspiration-proof. Dimensions 100x61x1,5 cm.

cod. MAT-100PRO - blu/blue

cod. MAT-101PRO - arancione/orange



MATERASSINO FITNESS CON OCCHIELLI **FITNESS MAT WITH EYELETS**

I - Morbida e confortevole superficie antiscivolo. Dotato di occhielli per riporlo più comodamente in palestra. Dimensioni 172x61x1,5 cm.

EN - Soft and comfortable non-slip surface. Chromed eyelet for hang up storage in gyms. Dimensions 172x61x1,5 cm.

cod. MAT-172PRO - blu/blue

cod. MAT-171PRO - arancione/orange

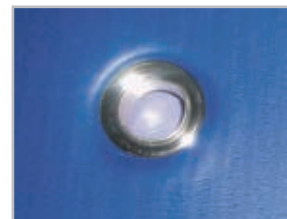

MATERASSINO PER YOGA BICOLORE PROFESSIONALE

PROFESSIONAL DUAL COLOR YOGA MAT

I - Materiale TPE. Superficie antiscivolo.
Leggero, arrotolabile, facilmente igienizzabile.
Dimensioni 183x60x0,6 cm

EN - TPE material. Non-slip surface.
Lightweight, rollable, easy to sanitize.
Dimensions 183x60x0,6 cm.

cod. MAT-183 - azzurro e grigio antracite/light blue
and dark grey

cod. MAT-184 - perla e rosso borgogna/pearl
and burgundy red



RASTRELLIERA PORTA MATERASSINI OCCHIELLATI A PARETE

WALL MATS RACK

cod. RMP-PRO

I - Rastrelliera porta materassini occhiellati a parete
con staffe regolabili in larghezza.
Dimensione prodotto: 70x26xH6 cm.

EN - Wall mats rack with adjustable eyelets. Product
size: 70x26xH6m.



RASTRELLIERA PORTA MATERASSINI OCCHIELLATI SU CARRELLO

STAND ALONE MATS RACK

cod. RMT-B

I - Rastrelliera porta materassini occhiellati su carrello con
ruote di trasporto e staffe regolabili in larghezza in modo
indipendente. Dimensione prodotto: 70x59xH190 cm.

EN - Mats rack with autonomously adjustable eyelets with
moving wheels. Product size: 70x59xH190 cm.





info@leos.gr
<https://leos.gr>

LEOS S.A. © 2024
ΕΔΡΑ ΑΘΗΝΑ: ΛΕΥΚΗΣ 111 ΚΡΥΟΝΕΡΙ, 145 68
Tel. +30 210 953 6512

ΘΕΣΣΑΛΟΝΙΚΗ: ΒΑΣ. ΟΛΓΑΣ 210 ΚΑΛΑΜΑΡΙΑ, 551 33
Tel. +30 2310 417 477